



BMW Motorrad



Rider's manual

R nineT/5

Vehicle data/dealership details

Vehicle data

Model

Vehicle Identification Number

Colour code

Date of first registration

Registration number

Dealership details

Person to contact in Service department

Ms/Mr

Phone number

Dealership address/phone number (company stamp)

Welcome to BMW

Dear BMW Motorrad friend,
With the BMW R nineT /5 anniversary model, BMW Motorrad presents an edition that is reminiscent of the R75/5 of 1969 and so revives the success story of a classic series. What was said back then holds true today: "The motorcycle constantly challenges the rider to engage in the adventure of man's dominance of machinery – directly, authentically. Wind, weather and the road have to be constantly reassessed and re-appraised – and mastered. As does the machine." In this spirit, we congratulate you on your choice of this special-edition model from BMW Motorrad and welcome you to the community of BMW riders. Familiarise yourself with your new vehicle so that you can ride it safely and confidently in all traffic situations.

About these operating instructions

Read these operating instructions carefully before starting to use your new BMW. They contain important information on how to operate the controls and how to make the best possible use of all your BMW's technical features. In addition, they contain information on maintenance and care to help you maintain your vehicle's reliability and safety, as well as its value.

The record of the maintenance work you have had performed on your vehicle is a precondition for generous treatment of goodwill claims.

If the time comes to sell your BMW, please remember to hand over these operating instructions to the new owner. They are an important part of the vehicle.

Suggestions and criticism

If you have questions concerning your vehicle, your authorised BMW Motorrad dealer will gladly provide advice and assistance.

We hope you will enjoy riding your BMW and that all your journeys will be pleasant and safe

BMW Motorrad.

01 40 9 446 781



Table of Contents

1 General instructions	5	3 Status indicators	23	Seat	54
Quick & easy reference	6	Indicator and warning lights	24	5 Adjustment.....	55
Abbreviations and symbols	6	Multifunction display	25	Mirrors	56
Equipment	7	Warning indicator lights	26	Headlight.....	56
Technical data	7	Service-due indicator	35	Clutch	57
Currency	7	4 Operation.....	37	Brakes	57
Additional sources of information.....	8	Ignition switch/steering lock	38	Spring preload	58
Certificates and operating licences	8	Emergency off switch (kill switch)	40	Damping	59
Data memory.....	8	Lights	40	6 Riding.....	61
2 General views	13	Hazard warning flashers.....	42	Safety instructions	62
General view, left side	15	Turn indicators	42	Checklist	64
General view, right side	17	Reading	44	Starting.....	64
Underneath the seat	18	Anti-theft alarm (DWA)	47	Running in	67
Multifunction switch, left	19	Clock.....	48	Brakes	68
Multifunction switch, right	20	Date.....	49	Parking your motorcycle	69
Instrument cluster	21	Adjusting brightness	50	Refuelling	70
		Antilock Brake System (ABS).....	51	Securing motorcycle for transportation	72
		Automatic Stability Control (ASC)	52		
		Heated handlebar grips	53		

7 Engineering details.....	75	9 Accessories	111	Chassis.....	129
General instructions	76	General instructions	112	Brakes	130
Antilock Brake System (ABS).....	76	Power sockets	112	Wheels and tyres.....	131
Automatic Stability Control (ASC)	78	Luggage	113	Electrical system	132
8 Maintenance	81	10 Care	115	Dimensions	133
General instructions	82	Care products.....	116	Weights	134
Toolkit.....	82	Washing the vehicle.....	116	Performance figures.....	134
Tool for adjusting spring struts.....	83	Cleaning easily damaged components.....	117	12 Service	135
Front-wheel stand.....	83	Care of paintwork	118	BMW Motorrad Service ...	136
Rear-wheel stand	84	Paint preservation	118	BMW Motorrad Service history.....	136
Engine oil	85	Laying up the motor- cycle	118	BMW Motorrad mobility services	137
Brake system	87	Restoring motorcycle to use	119	Maintenance work.....	137
Clutch.....	91	11 Technical data	121	Maintenance schedule ...	141
Tyres.....	91	Troubleshooting chart.....	122	Maintenance confirma- tions.....	142
Rims and tyres	92	Screw connections	123	Service confirmations	156
Wheels	93	Fuel	125		
Headlight.....	99	Engine oil	126		
Lighting	101	Engine	126		
Jump-starting	104	Clutch.....	127		
Battery	105	Transmission.....	127		
Fuses	107	Final drive	128		
Diagnostic connector.....	109	Frame.....	128		

13 Appendix	159
Declaration of conformity for electronic immobiliser	160
Certificate for electronic immobiliser	166
Certificate for anti-theft alarm	168
14 Index	174

General instructions

Quick & easy reference	6
Abbreviations and symbols	6
Equipment	7
Technical data	7
Currency	7
Additional sources of information	8
Certificates and operating licences	8
Data memory	8

Quick & easy reference

An important aspect of this Rider's Manual is that it can be used for quick and easy reference. Go straight to the "General views" chapter if you would like an initial overview of your motorcycle.

Abbreviations and symbols



CAUTION Low-risk hazard. Non-avoidance can lead to slight or moderate injury.



WARNING Medium-risk hazard. Non-avoidance can lead to fatal or severe injury.



DANGER High-risk hazard. Non-avoidance leads to fatal or severe injury.



ATTENTION Special notes and precautionary measures. Non-compliance can lead to damage to the vehicle or

accessory and, consequently, to voiding of the warranty.



NOTICE Specific instructions on how to operate, control, adjust or look after items of equipment on the vehicle.



Indicates the end of an item of information.



Instruction.



Result of an activity.



Reference to a page with more detailed information.



Indicates the end of a passage relating to specific accessories or items of equipment.



Tightening torque.



Technical data.

OE

Optional equipment. The vehicles are assembled complete with all the BMW Motorrad optional equipment originally ordered.

OA

Optional accessories. You can obtain BMW Motorrad optional accessories through your authorised BMW Motorrad dealer; optional accessories have to be retrofitted to the vehicle.

ABS

Anti-lock brake system.

ASC

Automatic Stability Control.

DWA

Anti-theft alarm.

EWS Electronic immobiliser.

Equipment

When you purchased your BMW motorcycle, you chose a model with individual equipment. These operating instructions describe the optional equipment (OE) offered by BMW and selected optional accessories (OA).

This explains why the manual may also contain descriptions of equipment that you might not have selected. Please note, too, that on account of country-specific differences, your motorcycle might not be exactly as illustrated.

If your motorcycle contains equipment that has not been described, its description can be found in a separate manual.

Technical data

All dimensions, weights and power ratings stated in the operating instructions are quoted to the standards and comply with the tolerance requirements of the Deutsches Institut für Normung e.V. (DIN).

Technical data and specifications in this rider's manual serve as reference points. The vehicle-specific data may deviate from these, for example as a result of selected optional equipment, the national-market version or country-specific measuring procedures. Detailed values can be taken from the vehicle registration documents and signs on the vehicle, or can be obtained from your authorised BMW Motorrad Retailer or another qualified service partner or specialist workshop. The specifications in the vehicle documents always have priority

over the information provided in this rider's manual.

Currency

The high safety and quality standards of BMW motorcycles are maintained by constant development work on designs, equipment and accessories. Because of this, your motorcycle may differ from the information supplied in these instructions. Nor can BMW Motorrad entirely rule out errors and omissions. We hope you will appreciate that no claims can be entertained on the basis of the data, illustrations or descriptions in these operating instructions.

Additional sources of information

Authorised BMW Motorrad dealer

Your BMW Motorrad Retailer will be happy to answer any questions you may have.

Internet

The rider's manual for your vehicle, operating and installation instructions for any accessories and general information on BMW Motorrad, for example relating to technology, are available at **www.bmw-motorrad.com/service**.

Certificates and operating licences

The certificates for the vehicle and the official operating licences for any accessories are available at **www.bmw-motorrad.com/certification**.

Data memory

General

Control units are installed in the vehicle. Control units process data that they receive, for example, from vehicle sensors, or that they generate themselves or exchange between each other. Some control units are required for the vehicle to function safely or provide assistance during riding, for example assistance systems. In addition, control units enable comfort or infotainment functions.

Information on data that has been stored or exchanged can be obtained from the manufacturer of the vehicle, for example via a separate booklet.

Personal reference

Each vehicle is identified with a clear vehicle identification number. Depending on the country, the vehicle identification num-

ber, the number plate and the corresponding authorities can be referenced to ascertain the vehicle owner. There are also other ways to use data obtained from the vehicle to trace the rider or vehicle owner, for example using the ConnectedDrive user account.

Data protection rights

In accordance with applicable data protection laws, vehicle users have certain rights in relation to the manufacturer of the vehicle or in relation to companies which collect or process personal data.

Vehicle users have the right to obtain full information at no cost from persons or entities storing personal data of the vehicle user. These entities may include:

- Manufacturer of the vehicle
- Qualified service partners
- Specialist workshops
- Service providers

Vehicle users have the right to request information on what personal data has been stored, for what purpose the data is used, and where the data comes from. To obtain this information, proof of ownership or use is required. The right to information also includes information about data that has been shared with other companies or entities. The website of the vehicle manufacturer contains the applicable data protection information. This data protection information includes information on the right to have data deleted or corrected. The manufacturer of the vehicle also provides their contact details and those of the data protection officer on their website.

The vehicle owner can also request that a BMW Motorrad Retailer or another qualified service partner or specialist workshop read out the data that is stored in the vehicle for a charge.

The vehicle data is read out using the legally prescribed socket for on-board diagnosis (OBD) in the vehicle.

Legal requirements for the disclosure of data

As part of its legal responsibilities, the manufacturer of the vehicle is obligated to make its stored data available to the relevant authorities. This data is provided in the required scope in individual cases, for example to clarify a criminal offence. In the context of applicable laws, public agencies are entitled in individual cases to read out data from the vehicle themselves.

Operating data in the vehicle

Control units process data to operate the vehicle.

This includes, for example:

- Status reports of the vehicle and its individual components, for example wheel revolutions, wheel speed, deceleration
- Environmental conditions, for example temperature

The data is only processed in the vehicle itself and is generally non-permanent. The data is not stored beyond the operating period.

Electronic components, for example control units, contain components for storing technical information. Information can be temporarily or permanently stored on the vehicle condition, component loads, incidents or errors. This information is generally used to document the condition of a component, a module, a system

or the surrounding area, for example:

- Operating conditions of system components, for example filling levels, tyre pressure
- Malfunctions and faults in important system components, for example light and brakes
- Response of the vehicle in special riding situations, for example engagement of the driving dynamics systems
- Information on incidents resulting in damage to the vehicle

The data is necessary for the provision of control unit functions. Furthermore, the data is used to detect and rectify malfunctions and to enable the vehicle manufacturer to optimise vehicle functions.

The vast majority of this data is non-permanent and is only processed in the vehicle itself. Only a small amount of the data is

stored in incident or fault memories as required by events.

If services are accessed, for example repairs, service processes, warranty cases and quality assurance measures, this technical information can be read out of the vehicle together with the vehicle identification number.

The information can be read out by a BMW Motorrad Retailer or another qualified service partner or specialist workshop. The legally stipulated socket for on-board diagnosis (OBD) in the vehicle is used to read out the data.

The data is obtained, processed and used by the relevant parts of the retailer network. The data is used to document the technical conditions of the vehicle, to help with error localization, to comply with warranty obligations and to improve quality.

In addition, the manufacturer has various product monitoring obligations arising from product liability legislation. To meet these obligations, the vehicle manufacturer requires technical data from the vehicle. The data from the vehicle can also be used to check warranty claims from the customer.

Error and incident memories in the vehicle can be reset during servicing or repair work by a BMW Motorrad Retailer or another qualified service partner or specialist workshop.

Data input and data transfer in the vehicle

General

Depending on the equipment, comfort and customised settings can be stored in the vehicle and can be changed or reset at any time.

This includes, for example:

- Settings of the windscreen position
- Chassis and suspension settings

If required, data can be entered in the entertainment and communication system of the vehicle, for example using a smartphone.

Depending on the individual equipment, this includes:

- Multimedia data, such as music for playback
- Contacts data for use in connection with a communication system or an integrated navigation system
- Entered destinations
- Data on the use of internet services. This data can be stored locally in the vehicle or is located on a device that is connected to the vehicle, for example smartphone, USB stick, MP3 player. If this data is

stored in the vehicle, the data can be deleted at any time.

This data is transferred to third parties only if personally requested within the context of using online services. This depends on the selected settings when using the services.

Incorporation of mobile end devices

Depending on the equipment, mobile end devices connected to the vehicle, for example smartphones, can be controlled using the operating elements of the vehicle.

The image and sound of the mobile end device can then be output via the multimedia system. At the same time, specific information is transferred to the mobile end device. Depending on the type of integration, this includes, for example, position data and additional general vehicle information. This enables optimal

use of the selected apps, for example navigation or music playback.

The type of additional data processing is determined by the provider of the respective app. The scope of the possible settings depends on the corresponding app and the operating system of the mobile end device.

Services General

If the vehicle has a wireless connection, this enables the exchange of data between the vehicle and other systems. The wireless connection is enabled by the vehicle's own transmitter and receiver unit or using personally integrated mobile end devices, for example smartphones. Online functions can be used using this wireless connection. These include online services and apps that are provided by the vehicle

manufacturer or by other providers.

Services of the vehicle manufacturer

For online services of the vehicle manufacturer, the individual functions are described at suitable points, for example rider's manual, website of the manufacturer. At the same time, information is also provided on the relevant data protection law. Personal data may be used to provide online services. Data is exchanged using a secure connection, for example with the IT systems provided by the vehicle manufacturer.

Obtaining, processing and using personal data outside of the normal provision of services requires legal permission, contractual agreement or consent. It is also possible to have the entire data connection activated or de-

activated. Statutory functions are excluded from this.

Services from other providers

When using online services from other providers, these services are subject to the responsibility and the data protection and operating conditions of the individual provider. The vehicle manufacturer has no influence on the content that is exchanged in this instance. Information on the type, scope and purpose of the data capture and use of personal data as part of the services of third parties can be ascertained from the individual provider.

General views

General view, left side.....	15
General view, right side	17
Underneath the seat	18
Multifunction switch, left	19
Multifunction switch, right.....	20
Instrument cluster	21

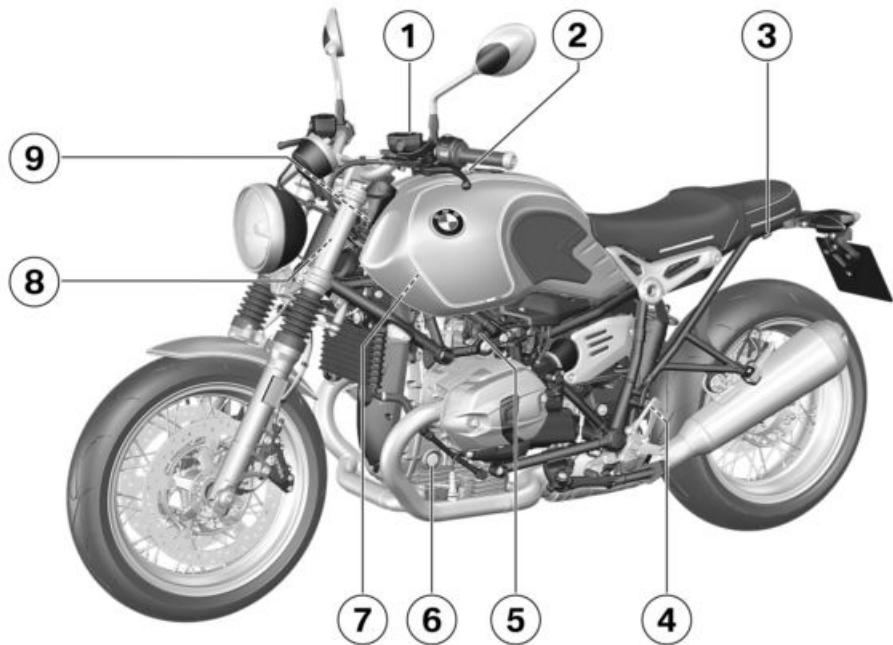

General view, left side

- 1 Check operation of the clutch (▮▮▮▮ 91).
- 2 Fuel filler neck
Fuel grade (▮▮▮▮ 70).
- 3 Load correctly (▮▮▮▮ 62).
Secure the luggage to motorcycle (▮▮▮▮ 113).
- 4 Adjust the damping for rear wheel (▮▮▮▮ 59).
- 5 Power socket (▮▮▮▮ 112)
- 6 Check the engine oil level (▮▮▮▮ 85).
- 7 Connector for optional accessories (underneath the tank)
- 8 Type plate (left side, on steering-head bearing)
- 9 Connector for rotational-speed sensor (optional accessories)

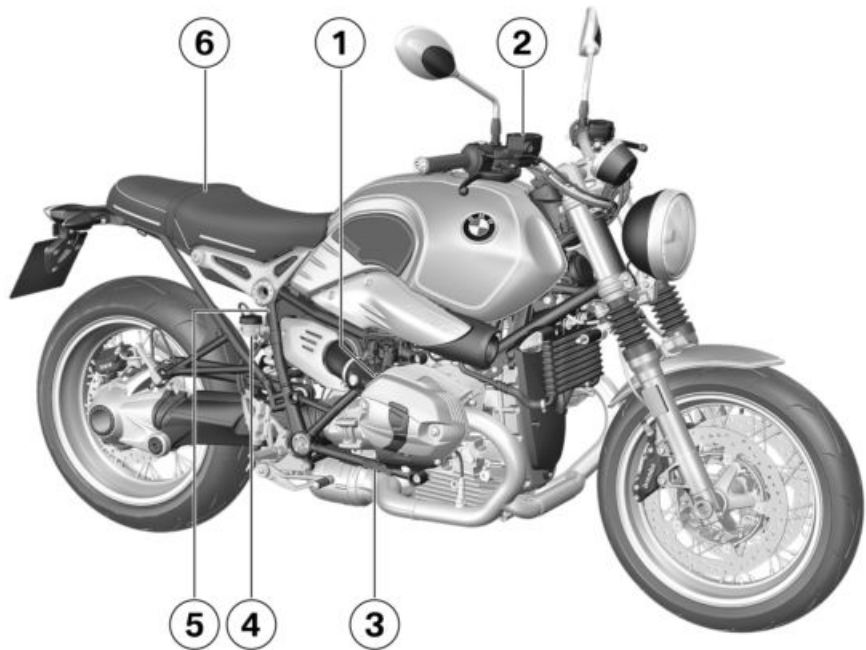

General view, right side

- 1 Top up the engine oil (▣▣▣▣ 86).
- 2 Check the brake-fluid level, front brakes (▣▣▣▣ 89).
- 3 Vehicle identification number
- 4 Check the brake-fluid level, rear brakes (▣▣▣▣ 90).
- 5 Adjust the spring preload for rear wheel (▣▣▣▣ 58).
- 6 Remove the seat (▣▣▣▣ 54).
Install the seat (▣▣▣▣ 54).

Underneath the seat

- 1 Operating instructions
- 2 Remote positive terminal (►► 104)
- 3 Fuse box
Replace the fuses (►► 107).
- 4 Tyre pressures table
- 5 Payload table
- 6 Toolkit (►► 82)
- 7 Diagnostic connector
Disengage the diagnostic socket (►► 109).

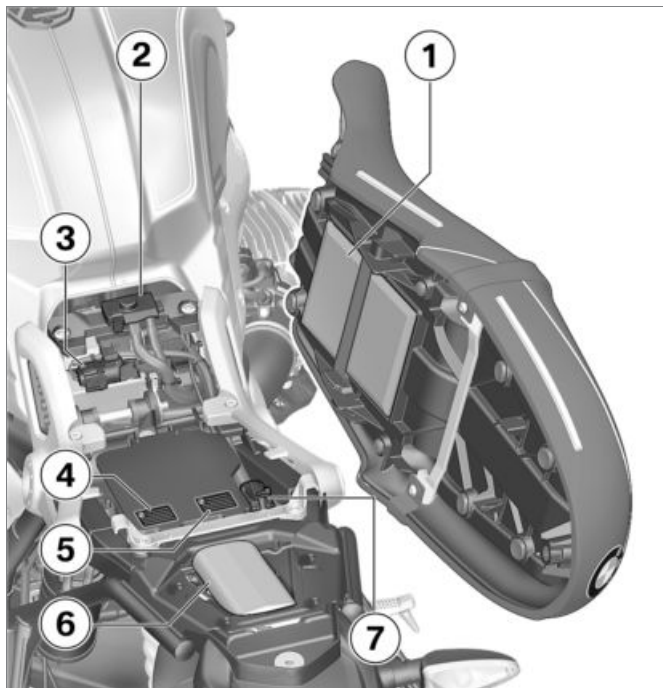

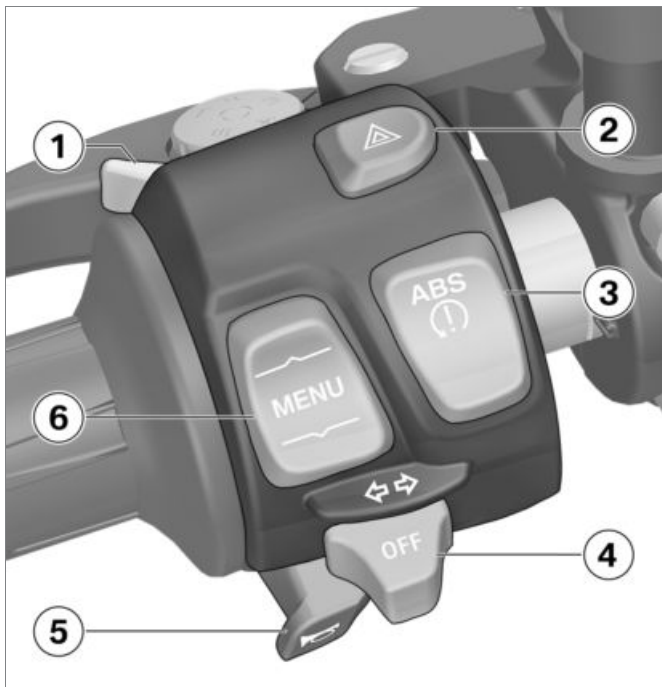

Multifunction switch, left

- 1 High-beam headlight and headlight flasher (►► 41)
- 2 Hazard warning flashers (►► 42)
- 3 Switch off the ABS (►► 51).
Switch off the ASC (►► 52).
- 4 Turn indicators (►► 42)
- 5 Horn
- 6 MENU rocker button
Multifunction display (►► 25)
Select displays. (►► 44)
Reset trip distance recorder. (►► 46)
Call up SETUP. (►► 48)

Multifunction switch, right

- 1 – with heated grips^{OE}
Operating the heated handlebar grips (➡ 53).
- 2 Emergency off switch (kill switch) (➡ 40)
- 3 Starter button
Start the engine (➡ 64).

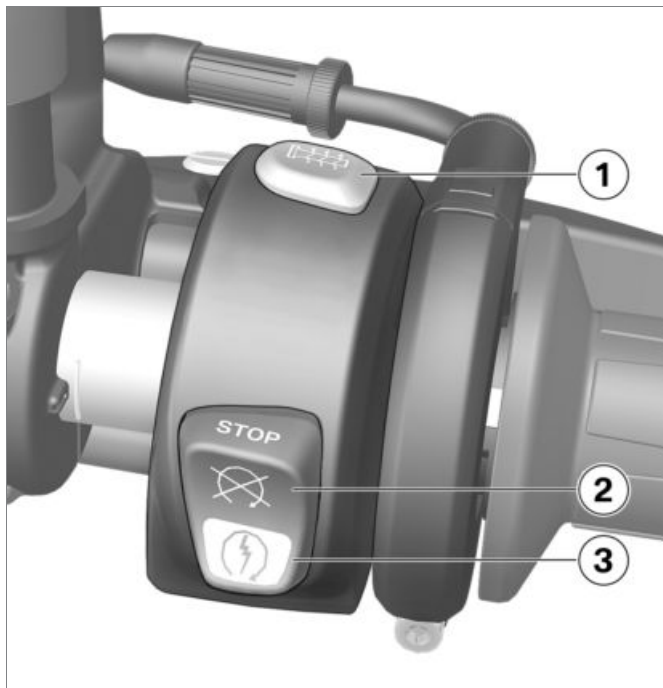



Instrument cluster

- 1 Speedometer
- 2 Indicator and warning lights (➡ 24)
- 3 Photosensor for the brightness control in the multifunction display
– with anti-theft alarm (DWA)^{OE}
DWA light-emitting diode (➡ 47)
- 4 Multifunction display (➡ 25)
Select the display (➡ 44).

Status indicators

Indicator and warning lights	24
Multifunction display	25
Warning indicator lights	26
Service-due indicator	35

Indicator and warning lights

- 1 Malfunction indicator lamp (►► 31)
- 2 High beam indicator light
Operation of high beam headlight and headlight flasher (►► 41).
- 3 General warning light
Displayed in combination with warning symbols in the multifunction display (►► 26)
- 4 Neutral indicator light
- 5 ASC indicator and warning light (►► 33)
- 6 Turn signal indicator light
Operating the turn indicators (►► 42).
- 7 ABS indicator and warning light

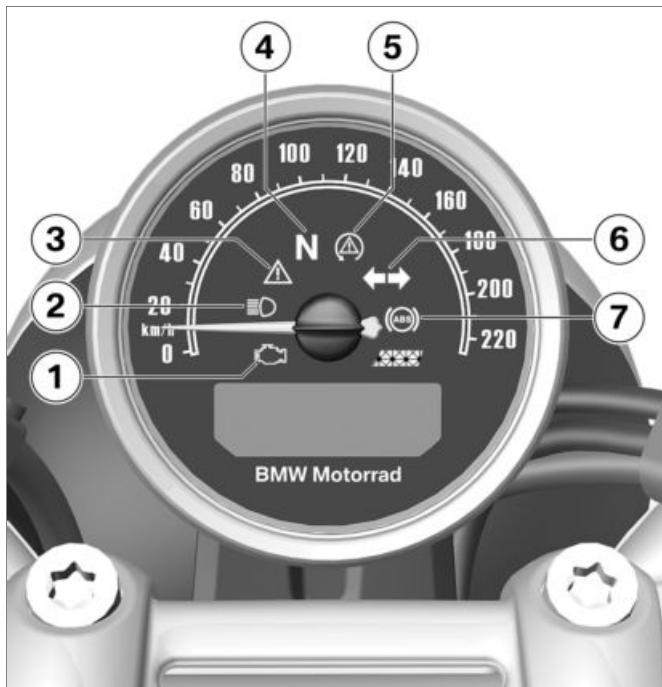



Multifunction display

- 1 Value
- 2 On-board computer
Select the display (→ 44).
- 3 Unit
- 4 Warning symbol
Displayed in combination
with the 'General' warning
light (→ 26)

Warning indicator lights

Mode of presentation

Warnings are indicated by the corresponding warning lights.

If two or more warnings occur at the same time, all the appropriate warning lights and warning symbols appear.

The possible warnings are listed on the next pages.



Warnings that do not have warning lights of their own are indicated by a warning symbol **1** appearing in the multifunction display in combination with 'Gen-













eral' warning light **2**. The 'General' warning light either shows steadily or flashes, depending on the urgency of the warning.

Warnings, overview

Indicator and warning lights

Display text

Meaning

 General warning light lights up.	 Key symbol is displayed.	Electronic immobiliser active (▬▬▬▶ 30)
 General warning light flashes.	 Temperature symbol is displayed.	Coolant temperature too high (▬▬▬▶ 30)
 General warning light lights up.	 Engine symbol is displayed.	Engine in emergency-operation mode (▬▬▶ 30)
 General warning light flashes.	 Engine symbol is displayed.	Engine warning (▬▬▶ 31)
 The malfunction indicator lamp lights up.		Emissions warning (▬▶ 31)
 General warning light lights up.	 Battery symbol is displayed.	Voltage of the vehicle electrical system too low (▬▬▶ 31)
 General warning light lights up.	 Lamp symbol is displayed.	Bulb faulty (▬▬▶ 32)

Indicator and warning lights

Display text

Meaning



ABS indicator and warning light flashes.

ABS self-diagnosis not completed (▬▬▬ 32)



ABS indicator and warning light comes on.

ABS switched off (▬▬▬ 32)



ABS indicator and warning light comes on.

ABS fault (▬▬▬ 33)



ASC indicator and warning light quick-flashes.

ASC intervention (▬▬▬ 33)



ASC indicator and warning light slow-flashes.

ASC self-diagnosis not completed (▬▬▬ 33)



ASC indicator and warning light comes on.

ASC switched off (▬▬▬ 33)



ASC indicator and warning light comes on.

ASC fault (▬▬▬ 33)

Indicator and warning lights

Display text

Meaning



Symbol for the DWA battery is displayed.

Anti-theft alarm battery flat ( 34)



General warning light lights up.



Symbol for fuel reserve and TRIP R countdown for distance that can potentially still be covered are displayed.

Fuel down to reserve ( 34)



General warning light lights up.



Symbol for service due is displayed.

Service appointment has passed ( 35)

Electronic immobiliser active



General warning light lights up.



Key symbol is displayed.

Possible cause:

The key being used is not authorised for starting, or communication between key and engine electronics is disrupted.

- Remove all other vehicle keys from the same ring as the ignition key.
- Have the defective key replaced, preferably by an authorised BMW Motorrad dealer.

Coolant temperature too high



General warning light flashes.



Temperature symbol is displayed.



ATTENTION

Riding with overheated engine

Engine damage

- Compliance with the information set out below is essential. ◀

Possible cause:

The engine-oil temperature is too high.

- If possible, ride in the part-load range to cool down the engine.
- If the engine-oil temperature is frequently too high, have the fault rectified as soon as possible by a specialist workshop, preferably an authorised BMW Motorrad Retailer.

Engine in emergency-operation mode



General warning light lights up.



Engine symbol is displayed.



WARNING

Unusual ride characteristics when engine running in emergency-operation mode

Risk of accident

- Avoid accelerating sharply and overtaking. ◀

Possible cause:

The engine control unit has diagnosed a fault. In exceptional cases, the engine stops and refuses to start. Otherwise, the engine runs in emergency operating mode.

- You can continue to ride, but bear in mind that the usual en-

gine performance might not be available.

- Have the fault rectified as quickly as possible by a specialist workshop, preferably an authorised BMW Motorrad dealer.

Engine warning



General warning light flashes.



Engine symbol is displayed.



WARNING

Engine damage when running in emergency-operation mode

Risk of accident

- Ride slowly, avoid accelerating sharply and overtaking.
- If possible, have the vehicle picked up and have the fault rectified by a specialist work-

shop, preferably an authorised BMW Motorrad Retailer.◀

Possible cause:

The engine control unit has diagnosed a fault which may cause severe secondary faults. The engine is in emergency-operation mode.

- Avoid high load and rpm ranges if possible.
 - Have the fault rectified as quickly as possible by a specialist workshop, preferably an authorised BMW Motorrad dealer.
- » It is possible to continue to ride but not recommended.

Emissions warning



The malfunction indicator lamp lights up.

Possible cause:

The engine control unit has diagnosed a fault which affects the pollutant emissions.

- Have the fault rectified by a specialist workshop, preferably an authorised BMW Motorrad dealer.
- » You can continue riding; pollutant emissions are higher than the threshold values.

Voltage of the vehicle electrical system too low



General warning light lights up.



Battery symbol is displayed.



WARNING

Failure of the vehicle systems

Risk of accident

- Do not continue your journey.◀

Possible cause:

The battery is faulty.

- Have the fault rectified as quickly as possible by a specialist workshop, preferably an authorised BMW Motorrad dealer.

Bulb faulty



General warning light lights up.



Lamp symbol is displayed.



WARNING

Vehicle overlooked in traffic due to failure of the lights on the vehicle

Safety risk

- Replace defective bulbs as soon as possible; always carry a complete set of spare bulbs if possible. ◀

Possible cause:

One or more bulbs faulty.

- Visually inspect to ascertain which bulb is defective.
- Replacing bulbs for low-beam and high-beam headlight (▮▮▮▶ 101).
- Replacing bulb for side light (▮▮▮▶ 102).
- Replacing bulbs for front and rear turn indicators (▮▮▮▶ 103).
- Replacing LED rear light (▮▮▮▶ 104).

ABS self-diagnosis not completed



ABS indicator and warning light flashes.

Possible cause:



ABS self-diagnosis not completed

The ABS function is not available, because self-diagnosis did not complete. (The motorcycle has to reach a defined minimum speed for the wheel speed sensors to be checked: 5 km/h)

- Pull away slowly. Bear in mind that the ABS function is not available until self-diagnosis has completed.

ABS switched off



ABS indicator and warning light comes on.

Possible cause:

The rider has switched off the ABS.

- Switch on the ABS (▮▮▮▶ 51).

ABS fault



ABS indicator and warning light comes on.

Possible cause:

The ABS control unit has detected a fault. The ABS function is not available.

- You can continue to ride the vehicle, but make due provision for the fact that the ABS function is not available. Bear in mind the more detailed information on situations that can lead to an ABS fault (►► 77).
- Have the fault rectified as quickly as possible by a specialist workshop, preferably an authorised BMW Motorrad dealer.

ASC intervention



ASC indicator and warning light quick-flashes.

The ASC has detected a degree of instability at the rear wheel

and has intervened to reduce torque. The ASC indicator and warning light flashes longer than the duration of the ASC intervention. This affords the rider visual feedback on control intervention even after the critical situation has been dealt with.

ASC self-diagnosis not completed



ASC indicator and warning light slow-flashes.

Possible cause:



ASC self-diagnosis not completed

The motorcycle has to reach the following speed with the engine running for the wheel-speed sensors to be checked:

min 5 km/h

- Pull away slowly. Bear in mind that the ASC is not available

until self-diagnosis has completed.

ASC switched off



ASC indicator and warning light comes on.

Possible cause:

The rider has switched off the ASC.

- Switch on the ASC (►► 52).

ASC fault



ASC indicator and warning light comes on.

Possible cause:

The ASC control unit has detected a fault. The ASC function is not available.

- You can continue to ride. Bear in mind that the ASC function is not available. Bear in mind the more detailed information on situations that can lead to an ASC fault (►► 78).

- Have the fault rectified as quickly as possible by a specialist workshop, preferably an authorised BMW Motorrad dealer.

Anti-theft alarm battery flat

– with anti-theft alarm (DWA)^{OE}



Symbol for the DWA battery is displayed.



NOTICE

This error message shows briefly only after the Pre-Ride-Check completes. ◀

Possible cause:

The integral battery in the anti-theft alarm (DWA) has lost its entire original capacity. There is no assurance that the DWA anti-theft alarm will be operational if the vehicle's battery is disconnected.

- Consult a specialist workshop, preferably an authorised BMW Motorrad dealer.

Fuel reserve

The amount of fuel remaining in the fuel tank when the low-fuel warning light comes on depends on riding dynamics. The more the fuel moves inside the fuel tank (due to frequent changes in angle of lean, frequent braking and acceleration), the more difficult it becomes to determine the reserve volume of fuel remaining in the tank. For this reason, the reserve volume of fuel cannot be displayed exactly.



As soon as the low-fuel warning light comes on, the **TRIP R** reading for the distance that can potentially be covered with the fuel still on board appears and counts down. The distance that can still be travelled using the reserve

volume of fuel depends on the style of riding (fuel consumption) and the amount of fuel left in the tank.

After a refuelling stop, the distance counter for reserve fuel is reset if the amount of fuel in the tank is greater than the reserve quantity.

Fuel down to reserve



General warning light lights up.



Symbol for fuel reserve and **TRIP R** countdown for distance that can potentially still be covered are displayed.

WARNING

Irregular engine operation or engine shutdown due to lack of fuel

Risk of accident, damage to catalytic converter

- Do not run the fuel tank dry. ◀

Possible cause:

The fuel tank contains no more than the reserve quantity of fuel.

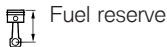

approx. 3.5 l

- Fuel grade (☰➔ 70).

Service appointment has passed



General warning light lights up.



Symbol for service due is displayed.

Service-due indicator



When a service is due within one month, symbol for service due **3** and service due date **2** are displayed. **SERV T 1** appears briefly on the display after the Pre-Ride-Check completes.



When a service is due within 1000 km, symbol for service due **3** and countdown distance **2** are displayed and the countdown proceeds in steps of 100 km. **SERV D 1** appears briefly on the display after the Pre-Ride-Check completes.



NOTICE

The date saved in the instrument cluster must be adjusted if the service display appears more than one month prior to the service date. This situation may

occur if the battery has been disconnected from the vehicle.◀

Operation

Ignition switch/steering lock	38
Emergency off switch (kill switch)	40
Lights	40
Hazard warning flashers	42
Turn indicators	42
Reading	44
Anti-theft alarm (DWA)	47
Clock	48
Date	49
Adjusting brightness	50
Antilock Brake System (ABS)	51
Automatic Stability Control (ASC)	52
Heated handlebar grips	53
Seat	54

Ignition switch/steering lock

Keys

You receive 2 ignition keys and a special key for removing the seat (► 54).

If a key is lost or mislaid, consult the information on the electronic immobiliser (EWS) (► 39).

Ignition switch/steering lock and the fuel filler cap lock are operated with the same key.

Lock the handlebars

- Turn the handlebars all the way to the left.

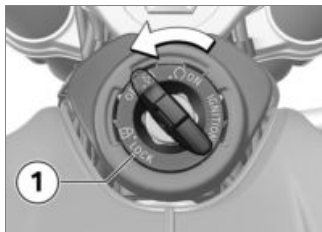

- Turn the ignition key to position **1** and move the handlebars slightly in the process.
 - » Ignition, lights and all function circuits are switched off.
 - » Handlebars are locked.
 - » Ignition key can be removed.

Switching on ignition

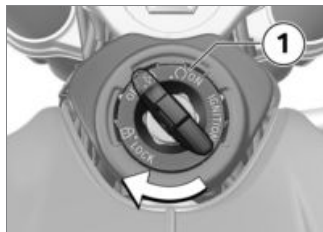

- Turn the ignition key to position **1**.
 - » Side lights and all function circuits are switched on.
 - » Engine can be started.
 - » Pre-Ride-Check is performed. (► 65)
 - » ABS self-diagnosis is in progress. (► 65)

Switching off ignition

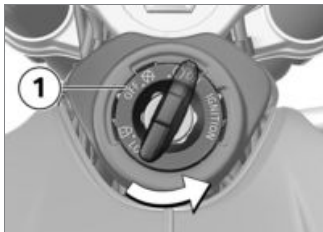

- Turn the ignition key to position **1**.
 - » Light switched off.
 - » Handlebars not locked.
 - » Ignition key can be removed.
 - » Electrically powered accessories remain operational for a limited period of time.
 - » The battery can be recharged via the socket.

Electronic immobiliser (EWS)

The on-board electronics access the data saved in the ignition key via a ring aerial in the ignition lock. The engine control unit will not permit the engine to be started unless the key is identified as “authorised”.



NOTICE

A spare key attached to the same ring as the ignition key used to start the engine could “irritate” the electronics, in which case the enabling signal for starting is not issued. The warning is displayed on the multifunction display with the key symbol.

Always keep the spare key separately from the ignition key.◀

If you lose your key, you can have it barred by your authorised BMW Motorrad dealer. If you wish to do this, you will need to bring all other keys for the motorcycle with you. The engine cannot be started by a barred key, but a key that has been barred can subsequently be reactivated.

You can obtain extra keys only through an authorised BMW Motorrad dealer. The keys are part of an integrated security system, so the dealer is under an obligation to check the legitimacy of all applications for replacement/extra keys.

Emergency off switch (kill switch)



- 1 Emergency off switch (kill switch)



WARNING

Operation of the kill switch while riding

Risk of fall due to rear wheel locking

- Do not operate the kill switch when riding. ◀

The emergency off switch is a kill switch for switching off the engine quickly and easily.

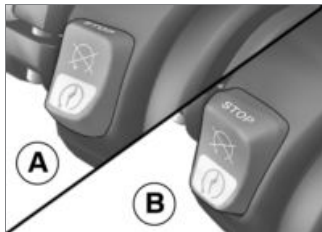

- A Engine switched off
B Normal operating position (run)



NOTICE

You cannot start the engine unless the kill switch is in the run position. ◀

Lights

Side light and low-beam headlight

The side lights switch on automatically when the ignition is switched on.



NOTICE

The side lights place a strain on the battery. Do not switch the ignition on for longer than absolutely necessary. ◀

The low-beam headlight switches on automatically when you start the engine.



NOTICE

When the engine is not running you can switch on the lights by switching on the ignition and either switching on the high-beam headlight or operating the headlight flasher. ◀

High-beam headlight and headlight flasher



- Push switch **1** forward to switch on the high-beam headlight.
- Press switch **1** back to operate the headlight flasher.

Parking lights

- Switch off the ignition (➡ 39).



- Immediately after switching off the ignition, push button **1** to the left and hold it in that position until the parking lights come on.
- Switch the ignition on and off again to switch off the parking lights.

Headlight courtesy delay feature

- Switch off the ignition.



- Immediately after switching off the ignition, pull switch **1** back and hold it in that position until the headlight courtesy delay feature comes on.
 - » The vehicle's lights come on for one minute and then switch off automatically.
 - This can be used to light up the path to the house door after the vehicle has been parked, for example.

Hazard warning flashers

Operating hazard warning flashers



NOTICE

The hazard warning flashers place a strain on the battery. Do not use the hazard warning flashers for longer than absolutely necessary. ◀

- Switch on the ignition (☛ 38).



- Press button **1** to switch on the hazard warning lights system.
- » Ignition can be switched off.
- To switch off the hazard warning flashers, switch on the ignition and press button **1** again.

Turn indicators

Operating the turn indicators

- Switch on the ignition (☛ 38).



- Push button **1** to the left to switch on the left turn indicators.
- Push button **1** to the right to switch on the right turn indicators.
- Press button **1** to switch off the turn indicator.

Comfort turn indicator



dicators only switch off automatically once the speed-dependent distance covered is reached.

If button **1** has been pressed to the right or left, the turn indicators are automatically switched off under the following circumstances:

- Speed below 30 km/h: after 50 m distance covered.
- Speed between 30 km/h and 100 km/h: after a speed-dependent distance covered or in case of acceleration.
- Speed over 100 km/h: after flashing five times.

If button **1** is pressed to the right or left slightly longer, the turn in-

Reading

Selecting display

Requirement

The vehicle is at a standstill.

- Switch on the ignition (III → 38).
» The on-board computer readings appear on the display.
- Repeatedly short-press button **1** until the desired value is displayed.

Possible displays:

- Total distance travelled: ODO
- Trip distance 1: TRIP 1
- Trip distance 2: TRIP 2
- Automatic trip recorders:
TRIP A is reset automatically when 5 hours have elapsed after the ignition was switched off and the date has changed.
- Distance ridden after fuel down to reserve: TRIP R, selectable only after the fuel level has dropped to the reserve volume.
- Engine temperature: ENGTMP



- Clock: CLOCK
- Call up the menu for settings:
SETUP ENTER

Resetting trip recorder

- Switch on the ignition (☛ 38).

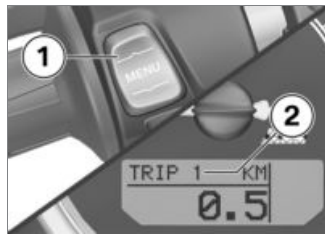

- Repeatedly short-press button **1** until the trip recorder you want to reset **2** is displayed.
- Press and hold down button **1** until trip recorder **2** is reset.

Anti-theft alarm (DWA)

– with anti-theft alarm (DWA)^{OE}

Activating DWA

- Switch on the ignition (▶▶▶▶ 38).
- Adjust the DWA settings (▶▶▶▶ 48).
- Switch off the ignition.
 - » If the alarm system (DWA) is activated, the DWA will be armed automatically when you switch off the ignition.
 - » Activation takes approximately 30 seconds to complete.
- Turn indicators flash twice.
- Confirmation tone sounds twice (if programmed).
 - » Anti-theft alarm (DWA) is active.

Alarm signal

A DWA alarm can be triggered by:

- Motion sensor
- An attempt to use an unauthorised ignition key to switch on the ignition.
- Disconnection of the DWA anti-theft alarm from the motorcycle's battery (DWA internal battery in the anti-theft alarm provides power - acoustic alarm only, the turn indicators do not flash).

All functions are sustained even if the internal battery of the DWA anti-theft alarm system is flat; the only difference is that an alarm cannot be triggered if the system is disconnected from the motorcycle's battery.

The alarm signal continues for approx. 26 seconds. While a DWA alarm is in progress an acoustic alarm sounds and the turn indicators flash. The type of acoustic alarm can be set by

an authorised BMW Motorrad dealer.

If a DWA alarm was triggered while the motorcycle was unattended, the rider is notified accordingly by an alarm tone sounding once when the ignition is switched on. The DWA LED then indicates the reason for the DWA alarm for one minute.

Light signals issued by the DWA LED:

- Flashes 1x: motion sensor 1
- Flashes 2x: motion sensor 2
- Flashes 3x: ignition switched on with unauthorised vehicle key
- Flashes 4x: disconnection of the DWA anti-theft alarm from the motorcycle's battery
- Flashes 5x: motion sensor 3

Deactivating DWA

- Switch on the ignition (III 38).
- » Turn indicators flash once.
- » Confirmation tone sounds once (if programmed).
- » Anti-theft alarm (DWA) is deactivated.

Adjusting DWA settings

- Switch on the ignition (III 38).



- Repeatedly short-press button **1** until SETUP ENTER is displayed.
- Long-press button **1** to open SETUP.

» SET DWA is displayed.



- Short-press button **2** to change the set value. The following settings are available:
 - DWA ON: the DWA anti-theft alarm is active and will be armed automatically when the ignition is switched off.
 - DWA OFF: the DWA anti-theft alarm is deactivated.
- Long-press button **1** to exit SET DWA.
 - » SETUP ENTER is displayed.

Clock

Setting the clock



WARNING

Adjusting the clock when riding

Risk of accident

- Set the clock only when the motorcycle is stationary. ◀
- Switch on the ignition (III 38).



- Repeatedly short-press button **1** until SETUP ENTER is displayed.



- Repeatedly short-press button **1** until the desired value for display brightness **3** is set.
 - » A display brightness value in the range 1 ... 5 (dark ... bright) is set.
- Long-press button **1** to exit SET BRIGHT.
 - » SETUP ENTER is displayed.

Antilock Brake System (ABS)

Switching off ABS

- Switch on the ignition (➡ 38).

NOTICE

You have the option of deactivating the ABS function while the motorcycle is on the move. ◀



- Press and hold down button **1** until first ASC indicator and warning light **2** and then ABS indicator and warning light **3** change status.
 - » The ASC setting remains unchanged.

 ABS indicator and warning light comes on.

- Release button **1** within two seconds.

 ABS indicator and warning light remains on.

» ABS is switched off.

Switching on ABS



- Press and hold down button **1** until first ASC indicator and warning light **2** and then ABS indicator and warning light **3** change status.
 - » The ASC setting remains unchanged.

 ABS indicator and warning light goes out; if self-diagnosis has not completed, it starts flashing.

- You also have the option of switching the ignition off and then on again.

 If the ABS indicator and warning light remains on even though the vehicle has accelerated past the minimum speed after the ignition was switched off and then on again, an ABS fault has occurred.

min 10 km/h

Automatic Stability Control (ASC)

Switching off ASC

- Switch on the ignition (➡ 38).



NOTICE

You have the option of deactivating the ASC function while the motorcycle is on the move. ◀



- Press and hold down button **1** until ASC indicator and warning light **2** changes its status.
- » The ABS setting remains unchanged.



ASC indicator and warning light starts to show.

- Release button **1** within two seconds.



ASC indicator and warning light remains on.

» ASC is switched off.

Switching on ASC



- Press and hold down button **1** until ASC indicator and warning light **2** changes its status.



ASC indicator and warning light goes out; if self-diagnosis has not completed, it starts flashing.

- Release button **1** within two seconds.

 ASC indicator and warning light remains off or continues to flash.

- » ASC is switched on.
- You also have the option of switching the ignition off and then on again.

 If the ASC indicator and warning light remains on even though the vehicle has accelerated past the minimum speed stated below after the ignition was switched off and then on again, an ASC fault has occurred.

min 10 km/h

Heated handlebar grips

– with heated grips^{OE}

Operating the heated handlebar grips

NOTICE

The heating in the heated handlebar grips can be activated only when the engine is running.◀

NOTICE

The increase in power consumption caused by having the heated handlebar grips switched on can drain the battery if you are riding at low engine speeds. If the charge level is low, the heated handlebar grips are switched off to ensure the battery's starting capability.◀

- Start the engine (▶▶▶ 64).



- Repeatedly press button **1** until desired heating stage **2** appears on the display.

The handlebar grips have two-stage heating.

 100% heating power

 approx. 50% heating power

- » Stage 2 is for heating the grips quickly: it is advisable to switch back to stage 1 as soon as the grips are warm.
- » The selected heating stage will be saved if you allow a certain

length of time to pass without making further changes.

- To switch off the heated grips, repeatedly press button **1** until heated grip symbol **2** is no longer shown on the display.

Seat

Removing seat

- Make sure the ground is level and firm and place the motorcycle on its stand.

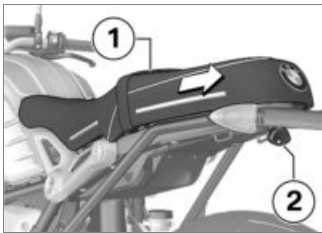

- Remove the screw with motorcycle seat key **2**.

- Pull seat **1** to the rear and remove.

Installing seat

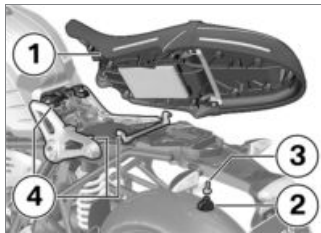

- Position seat **1** in the middle and push it forward into lugs **4**.
- Install screw **3** with motorcycle seat key **2**.

Adjustment

Mirrors	56
Headlight	56
Clutch	57
Brakes	57
Spring preload	58
Damping	59

Mirrors

Adjusting mirrors



- Turn the mirror to the desired position.

Adjusting mirror arm

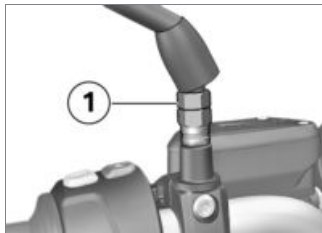

- Push the protective cap up over the screw connection on the mirror arm.
- Use the tool from the on-board toolkit to slacken nut **1**.
- Turn the mirror arm to the appropriate position.
- Tighten nut **1**, while holding the mirror arm to ensure that it does not move out of position.



Mirror (lock nut) to adapter

22 Nm (Left-hand thread)

- Push the protective cap over the threaded fastener.

Headlight

Headlight adjustment for right- or left-hand traffic

This motorcycle has a symmetric-beam low-beam headlight. If the motorcycle is ridden in a country where the opposite rule of the road applies, its symmetric low-beam headlight means that no measures are necessary to prevent the headlight beam from dazzling oncoming traffic.

Headlight beam throw and spring preload

Headlight beam throw is generally kept constant when spring preload is adjusted to suit load. However, a spring preload adjustment might not suffice if the motorcycle is very heavily

loaded. Under these circumstances, headlight beam throw has to be adjusted to suit the weight carried by the motorcycle.

NOTICE

If there are doubts about the correct headlight beam throw, have the setting checked by a specialist workshop, preferably an authorised BMW Motorrad dealer. ◀

Clutch

Adjusting clutch lever

WARNING

Relocated clutch-fluid reservoir

Air in the clutch system

- Do not turn the handlebars or the handlebar fitting on the handlebar. ◀

WARNING

Adjusting the clutch lever while riding

Risk of accident

- Adjust the clutch lever only when the motorcycle is at a standstill. ◀

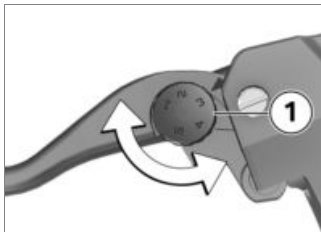

- Applying light pressure from behind, turn adjusting screw **1** to the desired position.

NOTICE

The adjusting screw can be turned more easily if the clutch lever is pushed forward. ◀

- » Adjustment options:
- from position 1: narrowest span between the handlebar grip and the clutch lever
 - to position 5: largest distance between the handlebar grip and the clutch lever

Brakes

Adjusting front brake lever

WARNING

Relocated brake fluid tank

Air in the brake system

- Do not turn the handlebars or the handlebar fitting on the handlebar. ◀

WARNING

Adjusting the brake lever while riding

Risk of accident

- Do not attempt to adjust the brake lever unless the motorcycle is at a standstill. ◀

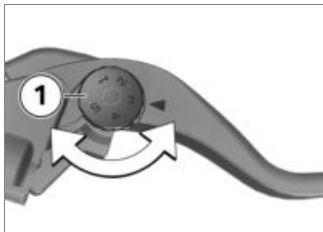

- Applying light pressure from behind, turn adjusting screw **1** to the desired position.

NOTICE

The adjusting screw is easier to turn if you push the brake lever forward. ◀

- » Adjustment options:
- from position 1: narrowest span between handlebar grip and brake lever
 - to position 5: widest span between handlebar grip and brake lever

Spring preload

Adjustment

It is essential to set spring preload of the rear suspension to suit the load carried by the motorcycle. Increase spring preload when the motorcycle is heavily loaded and reduce spring preload accordingly when the motorcycle is lightly loaded.

Adjusting spring preload for rear wheel

Requirement

Setting the spring preload requires 2 hook wrenches that are not included in the toolkit, but are nevertheless included in the delivery specification of the vehicle.

- Make sure the ground is level and firm and place the motorcycle on its stand.

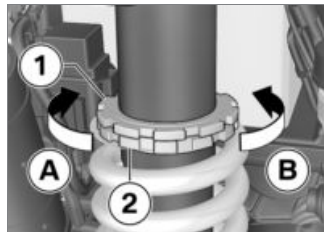

- Release the lock by turning adjusting ring **1** in direction **B** with one hook wrench, while

holding adjusting ring **2** with a second hook wrench.

- To increase spring preload, turn adjusting ring **2** in direction **A** with the hook wrench.
- To reduce spring preload, turn adjusting ring **1** in direction **B** with the hook wrench.
- Tighten the lock by tightening adjusting ring **1** in direction **A** with one hook wrench, while holding adjusting ring **2** with a second hook wrench.
- Adjust the damping characteristic to suit spring preload.
- Adjust the damping for rear wheel (►► 59).

Damping

Adjustment

Damping must be adapted to suit the condition of the surface on which the motorcycle is ridden and to suit spring preload.

- An uneven surface requires softer damping than a smooth surface.
- An increase in spring preload requires firmer damping, a reduction in spring preload requires softer damping.

Adjusting the damping for rear wheel

- Make sure the ground is level and firm and place the motorcycle on its stand.



CAUTION

Adjusting the spring-strut damping when the silencer is hot

Risk of burn injury

- Allow the silencer to cool.◀

CAUTION

Working with hot components

Risk of burn injury

- Wear protective gloves.◀
- Adjust the damping characteristic, using the tool from the

on-board toolkit to turn adjusting screw **1**.

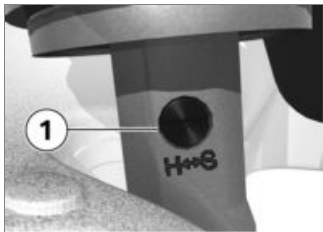

- Turn the adjusting screw **1** clockwise to harden the damping action.
- Turn the adjusting screw **1** anticlockwise to soften the damping action.

 Recommended suspension setting for one-up riding

18 mm to the beginning of the thread (Spring preload)

 Recommended suspension setting for one-up riding

Turn the adjusting screw all the way clockwise, then back it off 1.75 turns (Damping)

 Recommended suspension setting for riding with load

21 mm to the beginning of the thread (Spring preload)

Turn the adjusting screw all the way clockwise, then back it off 1.25 turns (Damping)

 Recommended suspension setting for two-up riding

28 mm to the beginning of the thread (Spring preload)

Turn the adjusting screw all the way clockwise, then back it off 0.5 turns (Damping)

Riding

Safety instructions	62
Checklist.....	64
Starting	64
Running in	67
Brakes	68
Parking your motorcycle	69
Refuelling	70
Securing motorcycle for transportation	72

Safety instructions

Rider's equipment

The following clothing will protect you on every journey:

- Helmet
- Suit
- Gloves
- Boots

This applies even to short journeys, and to every season of the year. Your authorised BMW Motorrad dealer will be glad to advise you on the correct clothing for every purpose.

Loading correctly



WARNING

Handling adversely affected by overloading and imbalanced loads

Risk of falling

- Do not exceed the permissible gross weight and be sure to

comply with the instructions on loading.◀

- Set spring preload, damping characteristic and tyre pressures to suit total weight.
- Pack heavy items at the bottom and toward the inboard side.
- with tank bag^{OA}
- Note the maximum permissible payload of the tank bag.



Payload of tank rucksack

≤5 kg◀

- with rear softbag^{OA}
- Note the maximum payload of the rear softbag.



Payload of rear softbag

max 10 kg◀

Speed

If you ride at high speed, always bear in mind that various boundary conditions can adversely affect the handling of your motorcycle, e.g.:

- Spring-strut and shock-absorber system not set up correctly
- Imbalanced load
- Loose clothing
- Insufficient tyre pressure
- Poor tyre tread
- On-board luggage systems such as a tank bag or rear softbag. Observe the speed limit indicated on the label in the respective luggage system.

Risk of poisoning

Exhaust fumes contain carbon monoxide, which is colourless and odourless but highly toxic.

WARNING

Exhaust gases adversely affecting health

Risk of asphyxiation

- Do not inhale exhaust fumes.
- Do not run the engine in an enclosed space.◀

Risk of burn injury

CAUTION

Engine and exhaust system become very hot when the vehicle is in use

Risk of burn injury

- When you park the vehicle make sure that no-one and no objects can come into contact with the hot engine and exhaust system.◀

Catalytic converter

If misfiring causes unburned fuel to enter the catalytic converter, there is a danger of overheating and damage.

The following guidelines must be observed:

- Do not run the fuel tank dry.
- Do not attempt to start or run the engine with a spark-plug cap disconnected.
- Stop the engine immediately if it misfires.
- Use only unleaded fuel.
- Comply with all specified maintenance intervals.

ATTENTION

Unburned fuel in catalytic converter

Damage to catalytic converter

- Note the points listed for protection of the catalytic converter.◀

Risk of overheating

ATTENTION

Engine running for prolonged period with vehicle at standstill

Overheating due to insufficient cooling; in extreme cases vehicle fire

- Do not allow the engine to idle unnecessarily.
- Ride away immediately after starting the engine.◀

Tampering

ATTENTION

Tampering with the motorcycle (e.g. engine management ECU, throttle valves, clutch)

Damage to the affected parts, failure of safety-relevant functions, voiding of warranty

- Do not tamper with the vehicle in any way that could result in tuned performance.◀

Checklist

Comply with checklist

- At regular intervals, use the checklist below to check your motorcycle.

Always before riding off

- Check operation of the brake system.
- Check operation of the lights and signalling equipment.
- Check operation of the clutch (▮▮▮ 91).
- Check the tyre tread depth (▮▮▮ 92).
- Check the tyre pressure (▮▮▮ 91).
- Check security of cases and luggage.

Every 3rd refuelling stop

- Check the engine oil level (▮▮▮ 85).
- Check the front brake pad thickness (▮▮▮ 87).
- Check the rear brake pad thickness (▮▮▮ 88).
- Check the brake-fluid level, front brakes (▮▮▮ 89).
- Check the brake-fluid level, rear brakes (▮▮▮ 90).

Starting

Starting engine

- Switch on the ignition (▮▮▮ 38).
 - » Pre-Ride-Check is performed. (▮▮▮ 65)
 - » ABS self-diagnosis is in progress. (▮▮▮ 65)
- Select neutral or, if a gear is engaged, pull the clutch lever.



NOTICE

You cannot start the motorcycle with the side stand extended and

a gear engaged. The engine will switch itself off if you start it with the gearbox in neutral and then engage a gear before retracting the side stand.◀

- Cold starts and low temperatures:
 - » Pull the clutch lever.



- Press the starter button **1**.



NOTICE

The start attempt is automatically interrupted if battery voltage is too low. Recharge the battery before you start the engine, or

use jump leads and a donor battery to start.

See the subsection on jump starting in "Maintenance" for more details. ◀

- » The engine starts.
- » Consult the troubleshooting chart below if the engine refuses to start. (▶▶ 122)

Pre-Ride-Check

When the ignition is switched, on the instrument cluster carries out a test of the instruments, the indicator and warning lights and the display, the "Pre-Ride-Check". The check is aborted if you start the engine before it completes.

Phase 1

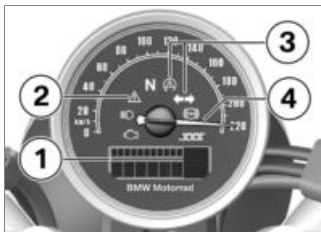

All the segments in display **1** light up.

At the same time, all the indicator and warning lights **3** are switched on.

Phase 2

'General' warning light **2** changes from ON to flashing.

The needle **4** for the speed indicator moves to maximum speed.

Phase 3

Needle **4** for the speedometer drops to the zero position.

The indicator and warning lights go out or assume operational status, as applicable.

The malfunction indicator lamp only goes out after 15 seconds.

The display switches to its ordinary display mode. The on-board computer readings appear on the display.

If the needle did not move, an indicator or warning light did not show or segments in the display failed to light up:

- Have the fault rectified as quickly as possible by a specialist workshop, preferably an authorised BMW Motorrad dealer.

ABS self-diagnosis

BMW Motorrad Integral ABS performs self-diagnosis to ensure its operability. Self-diagnosis starts

automatically when you switch on the ignition.

Phase 1

» Test of the diagnosis-compatible system components with the vehicle at a standstill.



ABS indicator and warning light flashes.

Phase 2

» Test of the wheel-speed sensors as the vehicle pulls away from rest.



ABS indicator and warning light flashes.

ABS self-diagnosis completed

» The ABS indicator and warning light goes out.



ABS self-diagnosis not completed

The ABS function is not available, because self-diagnosis did not complete. (The motorcycle has to reach a defined minimum speed for the wheel speed sensors to be checked: 5 km/h)

If an indicator showing an ABS fault appears when ABS self-diagnosis completes:

- You can continue to ride. Bear in mind that neither the ABS function nor the integral braking function is available.
- Have the fault rectified as quickly as possible by a specialist workshop, preferably an authorised BMW Motorrad dealer.

ASC self-diagnosis

BMW Motorrad ASC performs self-diagnosis to ensure its operability. Self-diagnosis is performed automatically when you switch on the ignition.

Phase 1

» Test of the diagnosable system components with the vehicle at a standstill.



ASC indicator and warning light slow-flashes.

Phase 2

» Test of the diagnosis-compatible system components while the motorcycle is on the move.



ASC indicator and warning light slow-flashes.

ASC self-diagnosis completed

» The ASC indicator and warning light goes out.

- Observe all the indicator and warning lights.

 ASC self-diagnosis not completed

The ASC function is not available, because self-diagnosis did not complete. (The motorcycle has to reach a defined minimum speed for the wheel sensors to be checked: min 5 km/h)

If an indicator showing an ASC fault appears when ASC self-diagnosis completes:

- You can continue to ride. Bear in mind that the ASC function is not available.
- Have the fault rectified as quickly as possible by a specialist workshop, preferably an authorised BMW Motorrad dealer.

Running in Engine

- Until the running-in check, vary the throttle opening and engine-speed range frequently; avoid riding at constant engine rpm for prolonged periods.
- Try to do most of your riding during this initial period on twisting, fairly hilly roads.
- Bear in mind the load condition when running in.

 Load condition for running in

no full load (Odometer reading 0...1000 km)

- Be aware of the running-in speeds.

 Running-in speeds

0...1000 km

max 50 km/h (1st gear)

 Running-in speeds

max 70 km/h (2nd gear)

max 90 km/h (3rd gear)

max 110 km/h (4th gear)

max 125 km/h (5th gear)

max 140 km/h (6th gear)

- Note the mileage after which the running-in check should be carried out.

 Mileage until the first running-in check

500...1200 km

Brake pads

New brake pads have to be run in before they can achieve their optimum frictional force. You can compensate for this initial reduction in braking efficiency by exerting greater pressure on the levers.

**WARNING****New brake pads**

Longer stopping distance, risk of accident

- Apply the brakes in good time.◀

Tyres

New tyres have a smooth surface. This must be roughened by riding in a restrained manner at various heel angles until the tyres are run in. Only once the surface has been roughened can the tyres achieve maximum grip.

**WARNING****New tyres losing grip on wet roads and at extreme bank angles**

Risk of accident

- Ride carefully and avoid extremely sharp inclines.◀

Brakes**How can stopping distance be minimised?**

Each time the brakes are applied, a load distribution shift takes place with the load shifting forward from the rear to the front wheel. The sharper the motorcycle decelerates, the more load is shifted to the front wheel. The higher the wheel load, the more braking force can be transmitted without the wheel locking.

To optimise stopping distance, apply the front brakes rapidly and keep on increasing the force you apply to the brake lever. This makes the best possible use of the dynamic increase in load at the front wheel. Remember to pull the clutch at the same time. In the extreme sudden-stop braking situations that are trained so frequently, braking force is applied as rapidly as possible and

with the rider's full force applied to the brake levers; under these circumstances the dynamic shift in load distribution cannot keep pace with the increase in deceleration and the tyres cannot transmit the full braking force to the surface of the road.

BMW Motorrad ABS prevents the front wheel from locking up.

**WARNING****Rear wheel lift due to severe braking**

Risk of falling

- When you brake sharply, bear in mind that ABS control cannot always be relied on to prevent the rear wheel from lifting clear of the ground.◀

Emergency braking

If you brake sharply from a speed in excess of 50 km/h the brake light flashes rapidly as a warning for road users behind you.

If you brake until your speed is less than 15 km/h, the hazard warning lights start to flash as well. The hazard warning lights switch off automatically as soon as you start to accelerate and vehicle speed reaches 20 km/h.

Descending mountain passes

WARNING

Braking only with the rear brake on mountain descents

Brake fade, destruction of the brakes due to overheating

- Use both front and rear brakes, and make use of the engine's braking effect as well. ◀

Wet and dirty brakes

Wetness and dirt on the brake discs and the brake pads diminish braking efficiency.

Delayed braking action or poor braking efficiency must be reckoned with in the following situations:

- Riding in the rain or through puddles of water.
- After the vehicle has been washed.
- Riding on salted or gritted roads.
- After work has been carried on the brakes, due to traces of oil or grease.
- Riding on dirt-covered surfaces or off-road.

WARNING

Wetness and dirt result in diminished braking efficiency

Risk of accident

- Apply the brakes lightly while riding to remove wetness and dirt, or dismount and clean the brakes.
- Think ahead and brake in good time until full braking efficiency is restored. ◀

Parking your motorcycle

Side stand

- Switch off the engine.



ATTENTION

Poor ground underneath the stand

Risk of damage to parts if vehicle topples

- Always check that the ground under the stand is level and firm. ◀

**ATTENTION****Additional weight placing strain on the side stand**

Risk of damage to parts if vehicle topples

- Do not sit or lean on the vehicle while it is propped on the side stand. ◀
- Extend the side stand and prop the motorcycle on the stand.
- If the camber of the roadway permits, turn the handlebars all the way to the left.
- On a gradient, the motorcycle should always face uphill; select 1st gear.

Refuelling**Fuel grade****Requirement**

For optimum fuel consumption, fuel should be sulphur-free or as low-sulphur as possible.

**ATTENTION****Engine operation with leaded fuel**

Damage to catalytic converter

- Do not attempt to run the vehicle on leaded fuel or fuel with metallic additives (e.g. manganese or iron). ◀
- Fuels with a maximum ethanol content of 15%, that is E15, can be used.



Recommended fuel grade



Super plus, unleaded
(max. 5 % ethanol, E5)



98 ROZ/RON
93 AKI



Alternative fuel grade



Premium unleaded (maximum 15% ethanol, E15)



95 ROZ/RON

» Pay attention to the following symbols in the fuel filler cap and on the fuel pump:

**Refuelling****WARNING****Fuel is highly flammable**

Risk of fire and explosion

- Do not smoke. Never bring a naked flame near the fuel tank. ◀

ATTENTION

Component damage

Component damage caused by overfilled fuel tank

- Overfilling the fuel tank will cause excess fuel to penetrate the carbon canister and cause component damage.
- Fill the fuel tank up to the lower edge of the filler neck only. ◀

ATTENTION

Wetting of plastic surfaces by fuel

Damage to the surfaces (surfaces become unsightly or dull)

- Clean plastic surfaces immediately after contact with fuel. ◀
- Make sure the ground is level and firm and place the motorcycle on its stand.

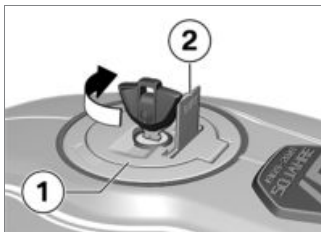

- Open the protective cap **2**.
- Use the ignition key to unlock filler cap of fuel tank **1** by turning it clockwise, and flip the cap open.

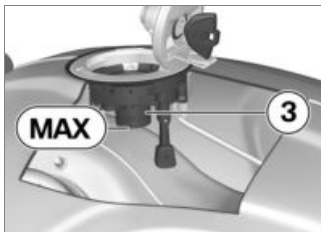

- Refuel with fuel of the grade stated below; do not fill the

tank past the bottom edge of the filler neck **3**.

NOTICE

When refuelling after running on reserve, make sure that you top up the tank to a level above reserve, so that the new level is detected and the fuel reserve indicator light is switched off. ◀

NOTICE

The "usable fuel capacity" specified in the technical data is the quantity that the fuel tank could hold if refilled after it had been run dry and the engine had cut out due to a lack of fuel. ◀



Fuel tank capacity

approx. 17.0 l



Fuel reserve

approx. 3.5 l

- Press the fuel filler cap down firmly to close.
- Remove the ignition key and close the protective cap.

Securing motorcycle for transportation

- Make sure that all components that might come into contact with straps used to secure the motorcycle are adequately protected against scratching. Use adhesive tape or soft cloths, for example, for this purpose.



ATTENTION

Vehicle topples to side when being lifted on to stand

Risk of damage to parts if vehicle topples

- Secure the vehicle to prevent it toppling, preferably with the assistance of a second person.◀
- Push the motorcycle onto the transportation flat and hold it in position: do not place it on the side stand.



ATTENTION

Trapping of components

Component damage

- Do not trap components such as brake lines or cable legs.◀
- At the front, loop a strap over the bottom fork bridge on each side.
- Pull the straps down and tight.



- At the rear, secure the straps to the frame for the passenger footrests on both sides and tighten the straps.
- Uniformly tighten all the straps.
 - » The vehicle's springs are compressed.

Engineering details

General instructions.....	76
Antilock Brake System (ABS)	76
Automatic Stability Control (ASC)	78

General instructions

To find out more about engineering go to:

bmw-motorrad.com/technology

Antilock Brake System (ABS)

How does ABS work?

The amount of braking force that can be transferred to the road depends on factors that include the coefficient of friction of the road surface. Loose stones, ice and snow or a wet road all have much lower coefficients of friction than a clean and dry asphalt surface. The lower the coefficient of friction, the longer the stopping distance.

If the rider increases the brake pressure to the extent that the brake force exceeds the maximum transferable limit, the wheels start to lock and

the vehicle loses its directional stability; a fall is imminent. Before this situation can occur, ABS intervenes and adapts braking pressure to the maximum transferable braking force. The wheels continue to turn and the driving stability is retained irrespective of the road condition.

What are the effects of surface irregularities?

Surface irregularities can cause the wheels to lose contact temporarily with the road surface. If this happens the braking force that can be transmitted to the road can drop to zero. If the brakes are applied under these circumstances the ABS has to reduce braking force to ensure that directional stability is maintained when the wheels regain contact with the road surface. At this instant the ABS must assume an extremely low coef-

ficient of friction, so that the wheels will continue to rotate under all imaginable circumstances, because this is the precondition for ensuring directional stability. As soon as it registers the actual circumstances, the system reacts instantly and adjusts braking force accordingly to achieve optimum braking.

Rear wheel lift

Under very severe and sudden deceleration, however, it is possible that the BMW Motorrad ABS will be unable to prevent the rear wheel from lifting clear of the ground. If this happens the outcome can be a highsiding situation in which the motorcycle can flip over.

WARNING

Rear wheel lift due to severe braking

Risk of falling

- When you brake sharply, bear in mind that ABS control cannot always be relied on to prevent the rear wheel from lifting clear of the ground. ◀

What is the design baseline for BMW Motorrad ABS?

Within the limits imposed by physics, the BMW Motorrad ABS ensures directional stability on any surface.

At speeds above 4 km/h, within the limits imposed by physics the BMW Motorrad ABS can ensure directional stability on any surface. Limitations inherent to the design principle mean that at lower speeds the

BMW Motorrad ABS cannot provide optimum assistance on all surfaces.

The system is not optimised for special requirements that apply under extreme competitive situations off-road or on the track.

Special situations

The speeds of the front and rear wheels are compared as one means of detecting a wheel's incipient tendency to lock. If the system registers implausible values for a lengthy period the ABS function is deactivated for safety reasons and an ABS fault message is issued. Self-diagnosis has to complete before fault messages can be issued. In addition to problems with the BMW Motorrad ABS, exceptional riding conditions can lead to a fault message being issued:

- Riding for a lengthy period with the front wheel lifted off the ground (wheelie)
- Rear wheel rotating with the vehicle held stationary by application of the front wheel brake (burn-out)
- Heating up with the motorcycle on the centre stand or an auxiliary stand, engine idling or with a gear engaged
- Rear wheel locked for a lengthy period, for example while descending off-road

If a fault message is issued on account of exceptional riding conditions, you can reactivate the ABS function by switching the ignition off and on again.

How important is regular maintenance?



WARNING

Brake system not regularly serviced

Risk of accident

- In order to ensure that the BMW Motorrad ABS is always maintained in optimum condition, it is essential for you to comply strictly with the specified inspection intervals.◀

Safety reserves

The potentially shorter braking distances which BMW Motorrad ABS permits must not be used as an excuse for careless riding. ABS is primarily a means of ensuring a safety margin in genuine emergencies.



WARNING

Braking when cornering

Risk of accident despite ABS

- Invariably, the rider bears responsibility for assessing road and traffic conditions and adopting his or her style of riding accordingly.
- Do not take risks that would negate the additional margin of safety offered by this system.◀

Automatic Stability Control (ASC)

How does ASC work?

The BMW Motorrad ASC system compares the speed of rotation of the front wheel and the rear wheel. The differential is used to compute slip as a measure of the reserves of stability available at the rear wheel. If slip exceeds a certain limit, the engine management system intervenes and adapts engine torque accordingly.

Special situations

In accordance with the laws of physics, the ability to accelerate is restricted more and more as the angle of heel increases. Consequently, there can be a perceptible lag in acceleration out of very tight bends.

The speeds of the front and rear wheels are compared as one means of detecting the rear wheel's incipient tendency to spin or slip sideways. If the system registers implausible values for a lengthy period the ASC function is deactivated for safety reasons and an ASC fault message is issued. Self-diagnosis has to complete before fault messages can be issued. The BMW Motorrad ASC can switch off automatically under the exceptional riding conditions outlined below.

Exceptional riding conditions:

- Riding for a lengthy period with the front wheel lifted off the ground (wheelie) with ASC deactivated
- Rear wheel rotating with the vehicle held stationary by application of the front brake (burn-out)
- Heating up with the motorcycle on the centre stand or an auxiliary stand, engine idling or with a gear engaged

Accelerating the motorcycle to a speed in excess of 5 km/h after switching the ignition off and then on again reactivates the ASC.

If the front wheel lifts clear of the ground under severe acceleration, the ASC reduces engine torque until the front wheel regains contact with the ground.

Under these circumstances, BMW Motorrad recommends rolling the throttle slightly closed so as to restore stability with the least possible delay.

When riding on a slippery surface, never snap the throttle twistgrip fully closed without pulling the clutch at the same time. Engine braking torque can cause the rear wheel to lock, with a corresponding loss of stability. The BMW Motorrad ASC is unable to control a situation of this nature.

Slippery surface

On very loose surfaces (for example sand or snow), the ASC's attempts to control propulsive power might reduce drive to the extent that the rear wheel no longer turns. Under these circumstances, BMW Motorrad re-

commends temporarily switching off ASC.

Bear in mind that the rear wheel will spin on the loose surface and close the throttle in good time before you reach a firm surface. Then reactivate ASC.

Maintenance

General instructions.....	82
Toolkit	82
Tool for adjusting spring struts.....	83
Front-wheel stand	83
Rear-wheel stand	84
Engine oil	85
Brake system	87
Clutch	91
Tyres	91
Rims and tyres.....	92
Wheels	93
Headlight	99
Lighting.....	101
Jump-starting.....	104
Battery.....	105

Fuses	107
Diagnostic connector	109

General instructions

The "Maintenance" chapter describes straightforward procedures for checking and replacing certain wear parts.

Special tightening torques are listed as applicable. The tightening torques for the threaded fasteners on your vehicle are listed in the section entitled "Technical data".

Further information on maintenance and repair work is available from your BMW Motorrad authorised dealer in the form of a DVD.

Some of the work requires special tools and a thorough knowledge of the technology involved. If you are in doubt, consult a specialist workshop, preferably your authorised BMW Motorrad dealer.

Toolkit

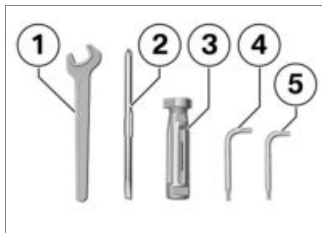

- 1** Open-ended spanner
Width across flats 14
– Adjust the mirror arm (►► 56).
- 2** Reversible screwdriver blade
With star-head and plain-tip ends
– Adjust the damping for rear wheel (►► 59).
– Replacing bulbs for front and rear turn indicators (►► 103).
- 3** Screwdriver handle

- 3** – Top up the engine oil (►► 86).
– Use with screwdriver insert
- 4** Torx bit, T25
– Loosen positive battery terminal.
- 5** T20 torx bit
– Replacing bulbs for low-beam and high-beam headlight (►► 101).
– Replacing bulb for side light (►► 102).

Tool for adjusting spring struts

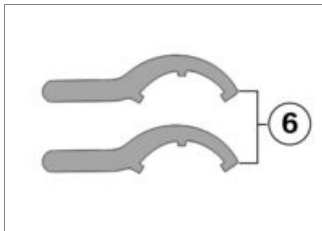

- 6** Hook wrench
– Adjust the spring preload for rear wheel (➡ 58).

Front-wheel stand Installing front-wheel stand



ATTENTION

Use of the BMW Motorrad front-wheel stand without also using the auxiliary stand

Risk of damage to parts if vehicle topples

- Place the motorcycle on an auxiliary stand before lifting the front wheel with the BMW Motorrad front-wheel stand. ◀
- Place the motorcycle on an auxiliary stand; BMW Motorrad recommends the BMW Motorrad auxiliary stand.
- Install the rear-wheel stand (➡ 84).
- Use basic stand with front-wheel adapter.
 - » The basic stand and its accessory components are available from your BMW Motorrad authorised dealer.

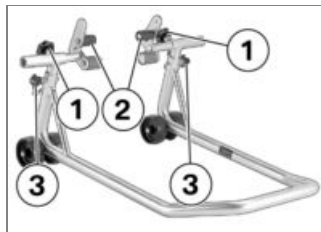

- Loosen clamping bolts **1**.
- Push the two adapters **2** apart until the front forks fit between them.
- Use locating pins **3** to set the front-wheel stand to the desired height.
- Centre the front wheel stand relative to the front wheel and push it into position at the front axle.

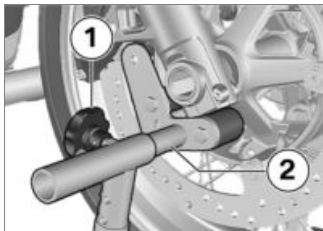

- Align the two adapters **2** so that the front forks are securely seated.
- Tighten clamping bolts **1**.

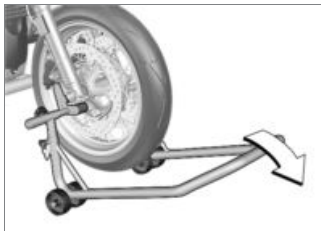

ATTENTION

Auxiliary stand lifts clear if the motorcycle is lifted too high

Risk of damage to parts if vehicle topples

- When lifting, make sure that the auxiliary stand remains in contact with the ground.
- If necessary, correct the height of the front-wheel stand or the auxiliary stand.◀
- Apply uniform pressure to push the front-wheel stand down and raise the motorcycle.

Rear-wheel stand

Installing rear-wheel stand

- Make sure the ground is level and firm and place the motorcycle on its stand.
- Use the rear-wheel stand with the rear axle adapters. The rear-wheel stand and its accessory components are available from your authorised BMW Motorrad dealer.

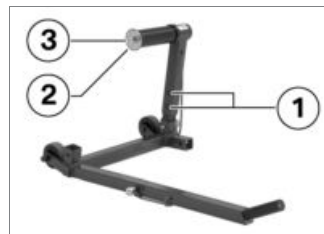

- Use screws **1** to set the rear-wheel stand to the desired height.

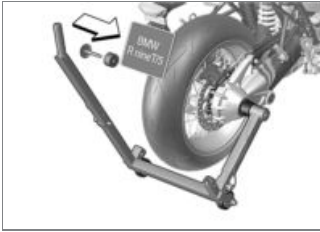

- Push the rear-wheel stand from the right onto the rear axle.
- Push the retaining disc on from the left, while holding the unlock button down.

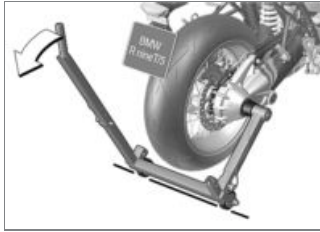

ATTENTION

Vehicle topples to side when being lifted on to stand

Risk of damage to parts if vehicle topples

- Secure the vehicle to prevent it toppling, preferably with the assistance of a second person. ◀
- Hold the motorcycle upright and at the same time press the handle of the stand back until both rollers of the stand are on the ground.
- Then press the handle down to the ground.

Engine oil

Checking engine oil level

ATTENTION

Misinterpretation of oil level reading, because oil level is temperature-dependent (the higher the temperature, the higher the oil level)

Engine damage

- Check the oil level only after a lengthy ride or when the engine is at operating temperature. ◀
- Switch off the engine when it is at operating temperature.
- Make sure the ground is level and firm and hold the motorcycle upright.
- Wait five minutes for the oil to drain into the oil pan.

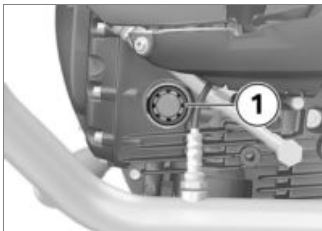

- Check the oil level in the display **1**.

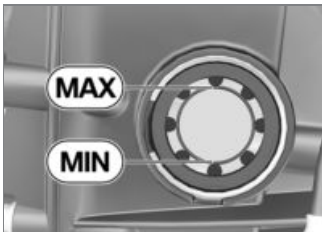

Engine oil, specified level

between **MIN** and **MAX** marks

If the oil level is below the MIN mark:

- Top up the engine oil (→ 86).

If the oil level is above the MAX mark:

- Have the oil level corrected by a specialist workshop, preferably an authorised BMW Motorrad dealer.



NOTICE

To protect the environment, BMW Motorrad recommends occasionally checking the engine oil after a journey of at least 50 km. ◀

Topping up the engine oil

- Make sure the ground is level and firm and place the motorcycle on its stand.

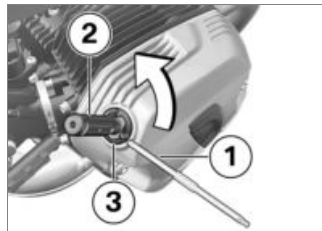

- Wipe the area around the oil filler opening clean.
- Insert cross-head end of reversible screwdriver insert **1** into screwdriver handle **2** (on-board toolkit).
- Engage the tool in cap **3** and turn the cap counter-clockwise.
- Remove cap **3** of the oil filler opening.



ATTENTION

Use of insufficient engine oil or too much engine oil

Engine damage

- Always make sure that the oil level is correct.◀
- Top up the engine oil to the specified level.

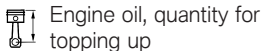

Engine oil, quantity for topping up

max 0.5 l (Difference between MIN and MAX)

- Check the engine oil level (→ 85).
- Install cap **3**.

Brake system

Checking operation of the brakes

- Operate the brake lever.
 - » There is a clearly perceptible pressure point.
- Press the footbrake lever.
 - » There is a clearly perceptible pressure point.

If pressure points are not clearly perceptible:



ATTENTION

Work on brake system not in compliance with correct procedure

Risk to operational reliability of the brake system

- Have all work on the brake system undertaken by trained and qualified specialists.◀
- Have the brakes checked by a specialist workshop, preferably an authorised BMW Motorrad dealer.

Checking front brake pad thickness



WARNING

Brake-pad thickness less than permissible minimum

Diminished braking effect, damage to the brakes

- In order to ensure the dependability of the brake system, do not permit the brake pads to wear past the minimum permissible thickness.◀
- Make sure the ground is level and firm and place the motorcycle on its stand.

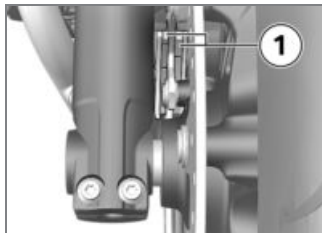

- Visually inspect the left and right brake pads to ascertain their thickness. Viewing direction: Between wheel and front suspension toward brake pads **1**.

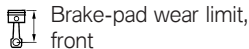

1.0 mm (friction pad only, without backing plate. The wear indicators (grooves) must be clearly visible.)

- Look out for wear indicating marks.

If the wear indicating marks are no longer clearly visible:

- Have the brake pads replaced by a specialist workshop, preferably an authorised BMW Motorrad dealer.

Checking rear brake pad thickness



WARNING

Brake-pad thickness less than permissible minimum

Diminished braking effect, damage to the brakes

- In order to ensure the dependability of the brake system, do not permit the brake pads to wear past the minimum permissible thickness. ◀
- Make sure the ground is level and firm and place the motorcycle on its stand.

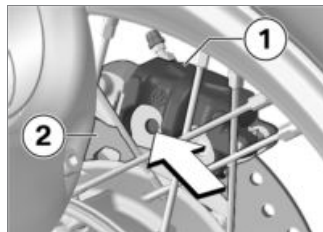

- Visually inspect the brake pads to ascertain their thickness. Viewing direction: from the left toward brake caliper **1**.

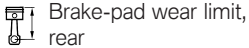
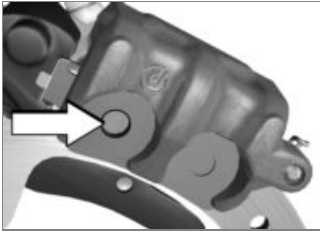

1.0 mm (friction pad only, without backing plate. Make sure that the brake disc is not visible through the bore in the inboard brake block.)

If brake disc **2** is visible:

- Have the brake pads replaced by a specialist workshop, preferably an authorised BMW Motorrad dealer.

Brake pad wear

The rear wheel brake has a brake-pad wear indicator.

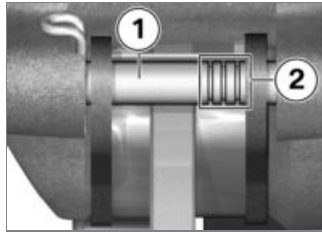

Shaft **1** with three marker rings **2** is between the brake pads.

How to interpret the marks:

- 3 rings visible: brake-pad thickness is at least 75 %
- 2 rings visible: brake pad thickness is at least 50 %
- 1 ring visible: brake pad thickness is at least 25 %

- No rings visible: wear limit reached; check as described above.

Checking brake-fluid level, front brakes

WARNING

Not enough brake fluid in brake fluid tank

Considerably reduced braking power due to air in the brake system

- Adjust the riding mode immediately until the fault is rectified.
- Check the brake-fluid level at regular intervals. ◀
- Make sure the ground is level and firm and hold the motorcycle upright.



- Turn the handlebars to a position in which the brake fluid reservoir is horizontal.
- Check the brake fluid level in inspection glass **1**.

**NOTICE**

Wear of the brake pads causes the brake fluid level in the reservoir to sink. ◀



Brake fluid level, front

Brake fluid, DOT4

It is not permissible for the brake fluid level to be below the MIN mark. (Brake-fluid reservoir horizontal, motorcycle upright.)

If the brake fluid level drops below the permitted level:

- Have the defect rectified as quickly as possible by a specialist workshop, preferably an authorised BMW Motorrad dealer.

Checking brake-fluid level, rear brakes

**WARNING**

Not enough brake fluid in brake fluid tank

Considerably reduced braking power due to air in the brake system

- Adjust the riding mode immediately until the fault is rectified.
- Check the brake-fluid level at regular intervals. ◀
- Make sure the ground is level and firm and hold the motorcycle upright.

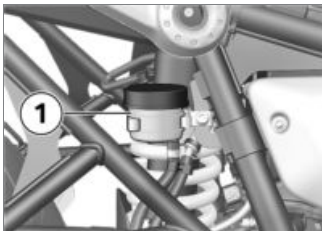

- Check brake fluid level on the brake fluid expansion tank **1**.

NOTICE

Wear of the brake pads causes the brake fluid level in the reservoir to sink. ◀



 Brake fluid level, rear

Brake fluid, DOT4

It is not permissible for the brake fluid level to be below the **MIN** mark. (Brake-fluid reservoir horizontal)

If the brake fluid level drops below the permitted level:

- Have the defect rectified as quickly as possible by a specialist workshop, preferably an authorised BMW Motorrad dealer.

Clutch

Checking operation of clutch

- Pull the clutch lever.
 - » There is a clearly perceptible pressure point.

If the pressure point is not clearly perceptible:

- Have the clutch checked by a specialist workshop, preferably an authorised BMW Motorrad dealer.

Tyres

Checking tyre pressure

WARNING

Incorrect tyre pressure

Impaired handling characteristics of the motorcycle, shorter useful tyre life

- Always check that the tyre pressures are correct. ◀

**WARNING****Tendency of valve inserts to open by themselves at high riding speeds**

Sudden loss of tyre pressure

- Install valve caps fitted with rubber sealing rings and tighten firmly. ◀
- Make sure the ground is level and firm and place the motorcycle on its stand.
- Check tyre pressures against the data below.



Tyre pressure, front

2.5 bar (One-up and two-up with luggage, tyre cold)



Tyre pressure, rear

2.7 bar (One-up, tyre cold)



Tyre pressure, rear

2.9 bar (Two-up mode with load, with cold tyres)

If tyre pressure is too low:

- Correct tyre pressure.

Rims and tyres**Checking rims**

- Make sure the ground is level and firm and place the motorcycle on its stand.
- Visually inspect the rims for defects.
- Have damaged rims checked and, if necessary, replaced by a specialist workshop, preferably an authorised BMW Motorrad dealer.

Checking spokes

- Make sure the ground is level and firm and place the motorcycle on its stand.

- Draw the handle of a screwdriver or a similar instrument across the spokes and listen to the sequence of sounds made by the individual spokes.

If there is a variation in the sequence of sounds:

- Have the spokes checked by a specialist workshop, preferably an authorised BMW Motorrad dealer.

Checking tyre tread depth**WARNING****Riding with badly worn tyres**

Risk of accident due to impaired handling

- If applicable, have the tyres changed in good time before they wear to the minimum tread depth permitted by law. ◀
- Make sure the ground is level and firm and place the motorcycle on its stand.

- Measure the tyre tread depth in the main tread grooves with wear marks.



NOTICE

Wear indicators are built into the main profile grooves on each tyre. The tyre is worn out when the tyre tread has worn down to the level of the marks. The locations of the marks are indicated on the edge of the tyre, e.g. by the letters TI, TWI or by an arrow. ◀

If the tyre tread is worn to minimum:

- Replace tyre or tyres, as applicable.

Wheels

Effect of wheel size on ABS

The wheel size has a large influence on the functionality of the ABS system. In particular, the diameter and the width of a vehicle's wheels are programmed into the control unit and are fundamental to all calculations. Any change in these influencing variables, caused for example by a switch to non-standard installed wheels, can have serious effects on the performance of the control systems.

The sensor rings are essential for correct wheel speed detection; they too must match the motorcycle's control systems and consequently cannot be replaced. If you decide that you would like to fit non-standard wheels to your motorcycle, it is very important to consult a specialist

workshop beforehand, preferably an authorised BMW Motorrad dealer. In some cases, the data programmed into the control units can be changed to suit the new wheel sizes.

Removing front wheel

- Place the motorcycle on an auxiliary stand. BMW Motorrad recommends you use the BMW Motorrad rear-wheel stand.
- Install the rear-wheel stand (▶▶▶ 84).
- Lift the front of the motorcycle until the front wheel is clear of the ground, preferably using a BMW Motorrad front-wheel stand.
- Install the front-wheel stand (▶▶▶ 83).
- Mask off the parts of the wheel rim that could be scratched when removing the brake caliper.

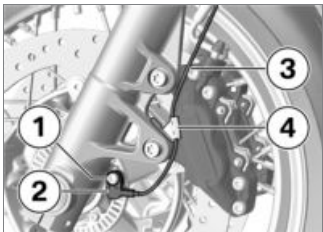

- Remove screw **1**.
- Release wheel speed sensor **2**.
- Disengage cable **3** from holder **4**.



- Remove screws **1**.

- Loosen left brake caliper **2**.

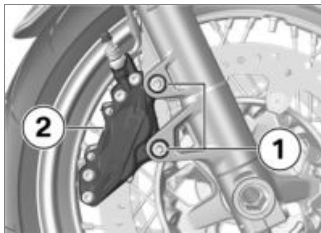

- Remove screws **1**.
- Loosen right brake caliper **2**.

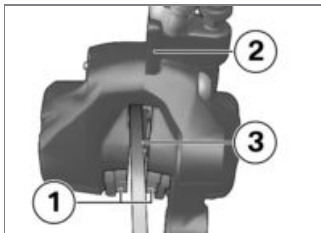

- Force brake pads **1** slightly apart by rocking brake caliper **2**

back and forth against brake disc **3**.



ATTENTION

Unwanted inward movement of the brake pads

Component damage on attempt to install the brake caliper or because brake pads have to be forced apart

- Do not operate the brakes with a brake caliper not correctly secured. ◀
- Carefully pull the brake calipers back and out until clear of the brake discs.

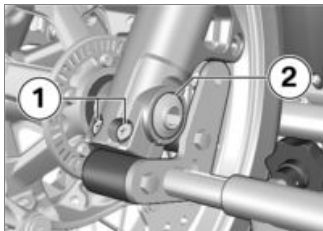

- Remove screw **2**.
- Slacken clamping bolts **1** on left and right.
- Press quick-release axle slightly toward the inside, so as to be better able to grip it on the right-hand side.

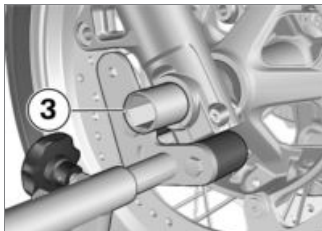

- Withdraw quick-release axle **3**, support the front wheel when doing this.
- Set down front wheel and roll forwards out of the front suspension.



- Remove spacer bush **4** from the wheel hub.

Installing front wheel

WARNING

Use of a non-standard wheel

Malfunctions in control attempts made by the ABS and ASC

- See the information on the effect of wheel size on the ABS and ASC systems at the start of this chapter. ◀

**ATTENTION****Tightening threaded fasteners to incorrect tightening torque**

Damage, or threaded fasteners work loose

- Always have the security of the fasteners checked by a specialist workshop, preferably an authorised BMW Motorrad dealer. ◀



- Lubricate the friction face of spacer bushing **4**.



Lubricant

Optimoly TA

- Install spacer bush **4**.

**ATTENTION****Front wheel installed wrong way round**

Risk of accident

- Note direction-of-rotation arrows on tyre or rim. ◀
- Roll the front wheel into position between the front forks.

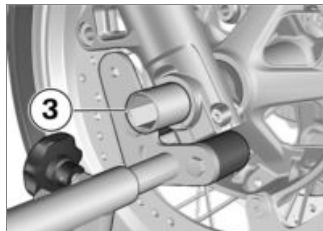

- Lubricate quick-release axle **3**.



Lubricant

Optimoly TA

**WARNING****Improper installation of the quick-release axle**

Loosening of the front wheel

- After securing the brake calipers and relieving the front forks, tighten the quick-release axle and the axle clamping to the specified tightening torque. ◀

- Lift the front wheel and insert quick-release axle **3**.
- Remove front-wheel stand and firmly compress front forks several times. Do not operate the brake lever in this process.
- Install the front-wheel stand (► 83).

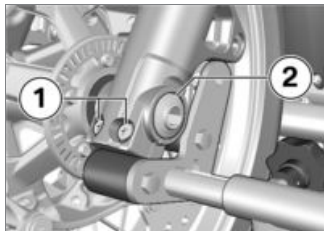



- Install screw **2**. Counter-hold quick-release axle on the right-hand side.

 Screw to quick-release axle

50 Nm

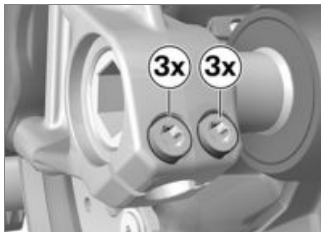
- Tighten clamping bolts **1** on the left and right to the specified torque.



 Clamping bolts in axle holder

Tightening sequence: Tighten screws six times in alternate sequence

19 Nm

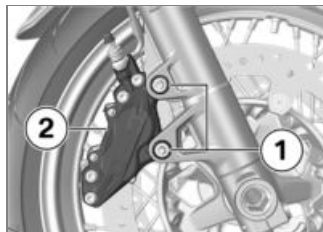

- Hold right brake caliper **2** in position and install screws **1**.

 Brake caliper to telescopic fork

38 Nm



- Hold left brake caliper **2** in position and install screws **1**.



Brake caliper to telescopic fork

38 Nm

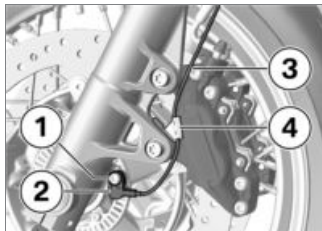

- Hold wheel speed sensor **2** in position.
- Install screw **1**.



Wheel-speed sensor to fork leg

8 Nm

- Secure cable **3** in holder **4**.
- Operate the brake several times until the brake pads are bedded.
- Remove the adhesive tape from the wheel rim.
- Remove the front-wheel stand.
- Extend the side stand.



ATTENTION

Vehicle topples to side when being lifted on to stand

Risk of damage to parts if vehicle topples

- Secure the vehicle to prevent it toppling, preferably with the assistance of a second person. ◀
- Remove the rear-wheel stand.
- Place the motorcycle on its side stand.

Removing rear wheel

- Lift the motorcycle, preferably with a BMW Motorrad rear-wheel stand.
- Install the rear-wheel stand (▶▶ 84).
- Engage first gear.

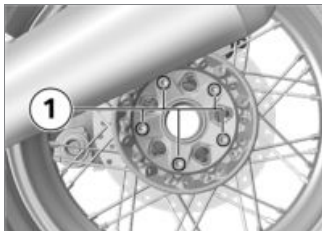

- Support the wheel and remove screws **1**.

ATTENTION

Use of hard or sharp-edged objects in proximity to component

Component damage

- Take care not to scratch components; cover or mask as necessary.◀
- Raise the rear wheel, swing out to the rear left and remove.

Installing rear wheel

WARNING

Use of a non-standard wheel

Malfunctions in control attempts made by the ABS and ASC

- See the information on the effect of wheel size on the ABS and ASC systems at the start of this chapter.◀
- Clean the wheel centring spigot and contact surfaces.

ATTENTION

Use of hard or sharp-edged objects in proximity to component

Component damage

- Take care not to scratch components; cover or mask as necessary.◀
- Fit the rear wheel from the rear left and set on the wheel carrier.

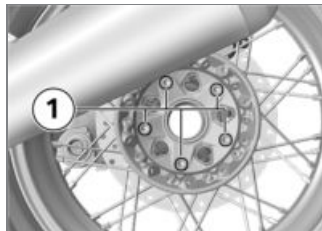

- Install screws **1**.

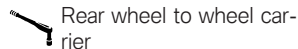

Tightening sequence: Tighten in diagonally opposite sequence

60 Nm

Headlight

Removing reflector

- Switch off the ignition (➡ 39).

- Make sure the ground is level and firm and place the motorcycle on its stand.

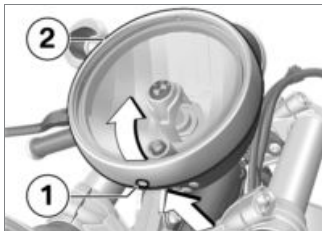

- Slacken screw **1** several turns.
- Carefully ease the bottom of reflector **2** in the direction indicated **arrow** and lift up to remove.
- » Bulb can be replaced.

Install the reflector

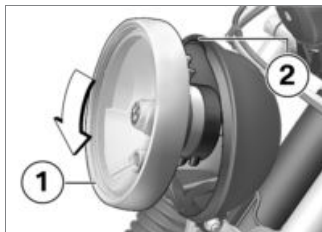

- Position reflector **1** behind lug **2** and pivot it down.
- Centre reflector **1**.

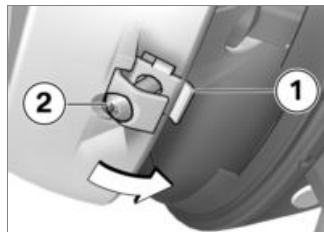

WARNING

Deformation of the clamp due to heavy impact on the light housing

Risk of accidents due to inadequately secured reflector

- Avoid all heavy impacts. ◀
- Use a screwdriver to push screw **2** up.
- Pivot the reflector back.
- » Clip **1** engages in the housing.
- Tighten screw **2**.

Lighting

Replacing bulbs for low-beam and high-beam headlight

- Switch off the ignition (➡ 39).
- Make sure the ground is level and firm and place the motorcycle on its stand.
- Removing reflector (➡ 100).

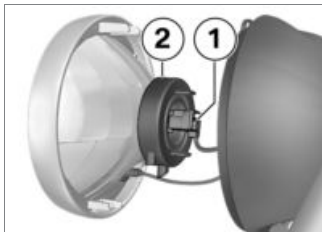

- Disconnect connector **1** for low-beam and high-beam headlight.
- Ease rubber cap **2** off the light housing.

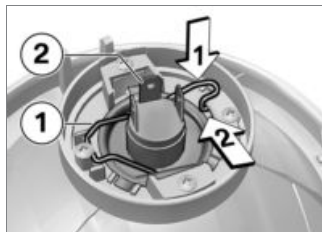

- Press wire spring clip **1** down and swing it aside clear of the lock, then flip the spring clip up to open.
- Remove bulb **2** for high-beam and low-beam headlight **carefully** from the light housing.
- Replace the defective bulb.



Bulb for low-beam and high-beam headlight

H4 / 12 V / 60/55 W

- Hold the bulb by the base only, in order to keep the glass free of foreign matter.

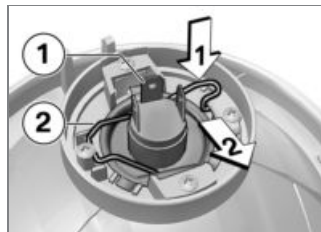

- Insert bulb **1** into the light housing.
- Flip wire spring clip **2** closed and seat it in the lock.

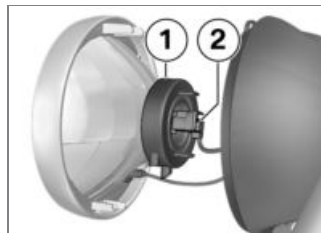

- Install rubber cap **1**.

- Connect connector **2** for the low-beam and high-beam headlight.
- Install the reflector.

Replacing bulb for side light

- Switch off the ignition (➡ 39).
- Make sure the ground is level and firm and place the motorcycle on its stand.
- Removing reflector (➡ 100).

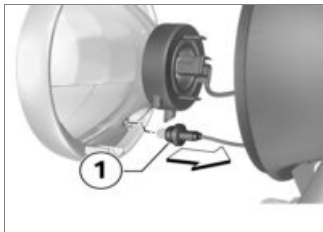

- Remove socket **1** for the side light from the light housing.

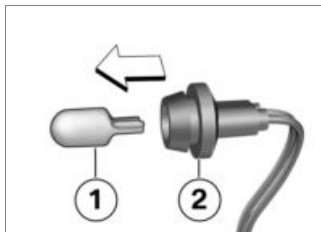

- Remove bulb **1** from socket **2**.
- Replace the defective bulb.



Bulb for parking light

W5W / 12 V / 5 W

- Use a clean, dry cloth to hold the bulb in order to keep the glass free of foreign matter.

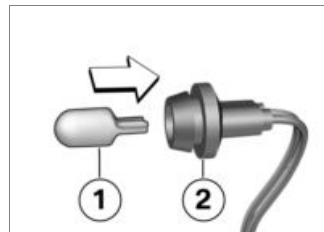

- Insert bulb **1** for the side light into socket **2**.

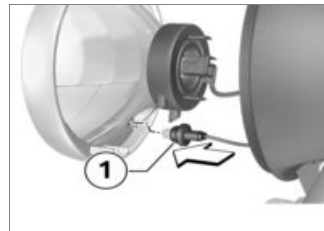

- Insert socket **1** for the side light into the light housing.
- Install the reflector.

Replacing bulbs for front and rear turn indicators

- Switch off the ignition (III → 39).
- Make sure the ground is level and firm and place the motorcycle on its stand.



- Remove screw **1**.



- Pull the glass out of the light housing at the threaded-fastener side.

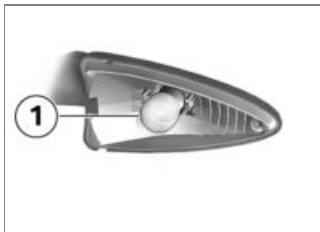

- Turn bulb **1** counter-clockwise to remove.

- Replace the defective bulb.

 Bulbs for flashing turn indicators, front

RY10W / 12 V / 10 W

 Bulbs for flashing turn indicators, rear

RY10W / 12 V / 10 W

- Use a clean, dry cloth to hold the bulb in order to keep the glass free of foreign matter.

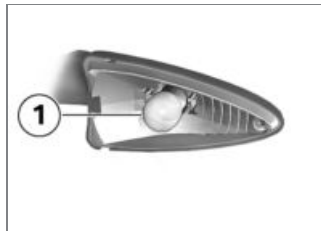

- Turn bulb **1** clockwise to install.



- Working from the inboard side, insert the glass into the light housing and close the housing.



- Install screw **1**.

Replacing LED rear light

If the LEDs in the rear light fail, the rear light must be replaced. Under these circumstances:

- Consult a specialist workshop, preferably an authorised BMW Motorrad dealer.

Jump-starting



CAUTION

Touching live parts of the ignition system when the engine is running

Electric shock

- Do not touch parts of the ignition system when the engine is running. ◀



ATTENTION

Excessive current flowing when the motorcycle is jump-started

Wiring smoulders/ignites or damage to the on-board electronics

- If the motorcycle has to be jump-started connect the leads to the battery terminals; never attempt to jump-start the engine by connecting leads to the on-board socket. ◀



ATTENTION

Contact between crocodile clips of jump leads and vehicle

Risk of short-circuit

- Use jump leads fitted with fully insulated crocodile clips at both ends. ◀



ATTENTION

Jump-starting with a voltage greater than 12 V

Damage to the on-board electronics

- Make sure that the battery of the donor vehicle has a voltage rating of 12 V.◀
- Make sure the ground is level and firm and place the motorcycle on its stand.
- Remove the seat (▣▣▣ 54).

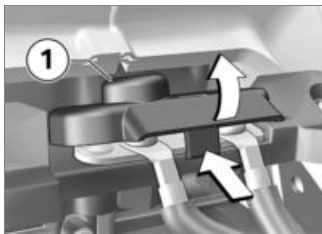

- Unclip cover **1** at the bottom (**arrow**) and work it up to remove.

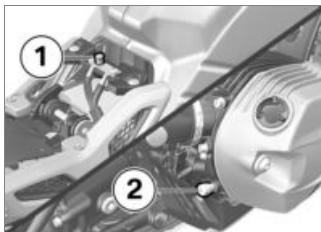

- Begin by connecting one end of the red jump lead to remote positive terminal **1** and the other end to the positive terminal of the donor battery.
- Connect one end of the black jump lead to vehicle's remote ground terminal **2** and the other end to the negative terminal of the donor battery.
- Run the engine of the donor vehicle during jump-starting.
- Start the engine of the vehicle in the usual way; if the engine does not start, wait a few minutes before repeating the

attempt in order to protect the starter motor and the donor battery.



NOTICE

Do not use proprietary start-assist sprays or other products to start the engine.◀

- Allow both engines to run for a few minutes before disconnecting the jump leads.
- Disconnect the jump lead from remote ground terminal **2** first, then disconnect the second jump lead from remote positive terminal **1**.
- Install the seat (▣▣▣ 54).

Battery

Maintenance instructions

Correct upkeep, recharging and storage will prolong the life of the battery and are essential if warranty claims are to be considered.

Compliance with the points below is important in order to maximise battery life:

- Keep the surface of the battery clean and dry.
- Do not open the battery.
- Do not top up with water.
- Follow the loading instructions on the following pages.
- Do not turn the battery upside down.



ATTENTION

On-board electronics (e.g. clock) draining connected battery

Battery is deep-discharged; this voids the guarantee

- Connect a float charger to the battery if the motorcycle is to remain out of use for more than four weeks.◀



NOTICE

BMW Motorrad has developed a float charger specially designed for compatibility with the electronics of your motorcycle. Using this charger, you can keep the battery charged during long periods of disuse, without having to disconnect the battery from the motorcycle's on-board systems. You can obtain additional information from your authorised BMW Motorrad dealer.◀

Recharging connected battery



ATTENTION

Unsuitable chargers connected to a socket

Damage to charger and vehicle electronics

- Use suitable BMW chargers.
The suitable charger is

available from your authorised BMW Motorrad dealer.◀

- Disconnect devices plugged into the socket.
- Comply with the operating instructions of the charger.
- Charge the battery connected to the vehicle's on-board electrical system via the socket.



NOTICE

The motorcycle's on-board electronics know when the battery is fully charged. The on-board socket is switched off when this happens.◀



NOTICE

If you are unable to charge the battery through the on-board socket, you may be using a charger that is not compatible with your motorcycle's electronics. In this case, directly charge the battery at the terminals of the bat-

tery that has been disconnected from the vehicle.◀

ATTENTION

Recharging a fully discharged battery via the power socket or extra socket

Damage to the vehicle electronics

- If a battery has discharged to the extent that it is completely flat (battery voltage less than 12 V, indicator lights and multifunction display remain off when the ignition is switched on) always charge the **disconnected** battery with the charger connected directly to the battery terminals.◀

ATTENTION

Charging the battery that is connected to the vehicle via the battery terminals

Damage to the on-board electronics

- Disconnect the battery at the battery terminals before charging.◀
- Charge the disconnected battery directly at the terminals.

Recharging disconnected battery

- Charge the battery using a suitable charger.
- Comply with the operating instructions of the charger.
- Once the battery is fully charged, disconnect the charger's terminal clips from the battery terminals.

NOTICE

The battery has to be recharged at regular intervals in the course of a lengthy period of disuse. See the instructions for caring for your battery. Always fully re-

charge the battery before restoring it to use.◀

Replacing battery

If there is a fault in the battery, seek the advice of a specialist workshop, preferably an authorised BMW Motorrad Retailer.

Fuses

Replacing fuses

ATTENTION

Jumpering of blown fuses

Risk of short-circuit and fire

- Never attempt to jumper a blown fuse.
- Always replace a defective fuse with a new fuse of the same amperage.◀
- Switch off the ignition.
- Make sure the ground is level and firm and place the motorcycle on its stand.

- Remove the seat (➔ 54).

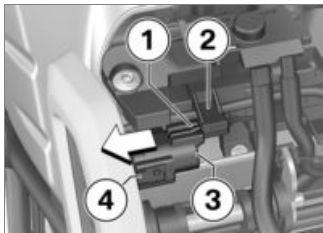

- Press hook **1**.
- » The fuse box is unlocked and can be pulled to the left and disengaged from holder **2**.
- Remove the fuse box from holder **2**.
- Press lock **4** on each side and remove cap **3**.



NOTICE

If fuse defects recur frequently have the electric circuits checked by a specialist workshop,

preferably an authorised BMW Motorrad dealer.◀

- Consult the fuse assignment diagram below and replace the defective fuse.
- » Fuse assignment (➔ 108)
- Re-install cap **3**. Make sure that lock **4** engages.
- Push the fuse box into holder **2** until hook **1** engages.
- Install the seat (➔ 54).

Fuse assignment

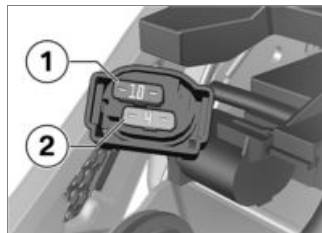

10 A (Instrument cluster, anti-theft alarm system (DWA), ignition switch, OBD diagnostic socket, ignition coil isolating relay)



Fuse 2

4 A (ABS control unit, engine control unit, output of isolating relay, speedometer, rev counter, alternator)

Diagnostic connector Disengaging diagnostic socket



CAUTION

Incorrect procedure followed when loosening the diagnostic connector for the on-board diagnosis

Motorcycle experiences malfunctions

- Only have the diagnostic connector loosened by a specialist workshop or other authorised persons during your next BMW Service appointment.

- Have the work performed by appropriately trained staff.
- Refer to the vehicle manufacturer specifications. ◀
- Remove the seat (▶▶▶ 54).

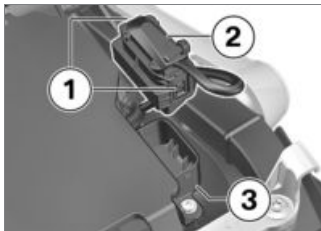

- Press locks **1**.
- Disengage diagnostic socket **2** from holder **3**.
 - » The interface to the diagnosis and information system can be connected to the diagnostic connector **2**.

Securing diagnostic socket

- Disconnect the interface for the diagnosis and information system.

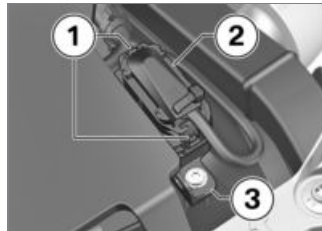

- Insert diagnostic socket **2** into holder **3**.
 - » The locks **1** engage.
- Install the seat (▶▶▶ 54).

Accessories

General instructions.....	112
Power sockets	112
Luggage	113

General instructions

CAUTION

Use of other-make products

Safety risk

- BMW Motorrad cannot examine or test each product of outside origin to ensure that it can be used on or in connection with BMW vehicles without constituting a safety hazard. Country-specific official authorisation does not suffice as assurance. Tests conducted by these instances cannot make provision for all operating conditions experienced by BMW vehicles and, consequently, they are not sufficient in some circumstances.
- Use only parts and accessories approved by BMW for your vehicle. ◀

BMW has conducted extensive testing of the parts and ac-

cessory products to establish that they are safe, functional and suitable. Consequently, BMW accepts responsibility for the products. BMW accepts no liability whatsoever for parts and accessories that it has not approved.

All modifications must be in compliance with legal requirements. Make sure that the vehicle does not infringe the national road-vehicle construction and use regulations applicable in your country.

Your BMW Motorrad dealer can offer expert advice on the choice of genuine BMW parts, accessories and other products.

To find out more about accessories go to:

bmw-motorrad.com/equipment

Power sockets

Notes on use of power sockets:

Automatic shutdown

The power sockets are shut down automatically under the following circumstances:

- If the battery voltage is too low to maintain the vehicle's starting capability
- If the maximum load capacity as stated in the technical data is exceeded
- During the starting operation

Connection of electrical devices

You can start using electrical devices connected to the motorcycle's sockets only when the ignition is switched on. The power supply to the sockets is switched off no more than 15 minutes after the ignition is switched off,

in order to prevent overloading of the on-board electrics.

Cable routing

Note the following with regard to the routing of cables from sockets to items of electrical equipment:

- Make sure that cables do not impede the rider.
- Make sure that cables do not restrict the steering angle or obstruct handling.
- Make sure that cables cannot be trapped.

Luggage

Securing luggage to motorcycle



Handling adversely affected by overloading and imbalanced loads

Risk of falling

- Do not exceed the permissible gross weight and be sure to comply with the instructions on loading. ◀



- Secure luggage (e.g. rear soft-bag) to lashing eyes **1**.
 - » You can obtain additional information on luggage systems and how to secure them correctly from your authorised BMW Motorrad dealer.

Care

Care products	116
Washing the vehicle	116
Cleaning easily damaged components.....	117
Care of paintwork	118
Paint preservation.....	118
Laying up the motorcycle	118
Restoring motorcycle to use	119

Care products

BMW Motorrad recommends that you use the cleaning and care products you can obtain from your authorised BMW Motorrad dealer. The substances in BMW Motorrad Care Products have been tested in laboratories and in practice; they provide optimised care and protection for the materials used in your vehicle.

ATTENTION

Use of unsuitable cleaning and care products

Damage to vehicle parts

- Do not use solvents such as cellulose thinners, cold cleaners, fuel or the like, and do not use cleaning products that contain alcohol. ◀

ATTENTION

Use of strongly acidic or strongly alkaline cleaning agents

Damage to vehicle parts

- Dilute in accordance with the dilution ratio stated on the packaging of the cleaning agent.
- Do not use strongly acidic or strongly alkaline cleaning agents. ◀

Washing the vehicle

BMW Motorrad recommends that you use BMW insect remover to soften and wash off insects and stubborn dirt on painted parts prior to washing the vehicle.

To prevent stains, do not wash the motorcycle immediately after it has been exposed to strong

sunlight and do not wash it in the sun.

Make sure that the vehicle is washed frequently, especially during the winter months.

To remove road salt, clean the motorcycle with cold water immediately after every trip.

WARNING

Wet brake discs and brake pads after vehicle wash, after riding through water and in rainy conditions

Diminished braking effect, risk of accident

- Apply the brakes in good time to allow the friction and heat to dry the brake discs and brake pads. ◀

ATTENTION

Effect of road salt intensified by warm water

Corrosion

- Use only cold water to wash off road salt.◀



ATTENTION

Damage due to high water pressure from high pressure cleaners or steam cleaners

Corrosion or short circuit, damage to labels, seals, hydraulic brake system, electrical system and the motorcycle seat

- Exercise restraint when using a steam jet or high pressure cleaning equipment.◀

Cleaning easily damaged components

Plastics



ATTENTION

Use of unsuitable cleaning agents

Damage to plastic surfaces

- Do not use cleaning agents that contain alcohol, solvents or abrasives.
- Do not use insect-remover pads or cleaning pads with hard, scouring surfaces.◀

Trim panel components

Clean trim panel components with water and BMW Motorrad solvent cleaner.

Headlight glass and lenses made of plastic

Remove dirt and insects with a soft sponge and plenty of water.



NOTICE

Soften stubborn dirt and insects by covering the affected areas with a wet cloth.◀



Clean with water and sponge only.



Do not use any chemical cleaning agents.

Chrome

Carefully clean chrome parts with plenty of water and motorcycle cleaner from the BMW Motorrad Care Products range. This is particularly important to counter the effects of road salt.

For an additional treatment, use BMW Motorrad metal polish.

Radiator

Clean the radiator regularly to prevent overheating of the engine due to inadequate cooling. For example, use a garden hose with low water pressure.



ATTENTION

Bending of radiator fins

Damage to radiator fins

- Take care not to bend the radiator fins when cleaning.◀

Rubber

Treat rubber components with water or BMW rubber-care products.



ATTENTION

Application of silicone sprays to rubber seals

Damage to the rubber seals

- Do not use silicone sprays or care products that contain silicon. ◀

Care of paintwork

Washing the vehicle regularly will help counteract the long-term effects of substances that can damage the paint, especially if your vehicle is ridden in areas with high air pollution or natural sources of dirt, for example tree resin or pollen.

Remove particularly aggressive substances immediately, however, as otherwise the paint

can be affected or become discoloured. Substances of this nature include spilt fuel, oil, grease, brake fluid and bird droppings. For this, we recommend BMW Motorrad solvent cleaner followed by BMW Motorrad gloss polish for preservation.

Marks on the paintwork are particularly easy to see after the motorcycle has been washed. Remove stains of this kind at the earliest possible opportunity, using cleaning benzene or petroleum spirit on a clean cloth or ball of cotton wool. BMW Motorrad recommends using BMW tar remover for removing specks of tar. Then apply preserving agent to the areas treated in this way.

Paint preservation

If water no longer rolls off the paint, the paint must be preserved.

For paint preservation, BMW Motorrad recommends the use of BMW Motorrad gloss polish or agents containing carnauba wax or synthetic wax.

Laying up the motorcycle

- Fill the motorcycle's fuel tank.
- Clean the motorcycle.
- Remove the battery.
- Spray the brake and clutch lever pivots and the side stand pivot mounts with a suitable lubricant.
- Coat bright metal and chrome-plated parts with an acid-free grease (e.g. Vaseline).
- Stand the motorcycle in a dry room in such a way that there is no load on either wheel.

Restoring motorcycle to use

- Remove the protective wax coating.
- Clean the motorcycle.
- Install a charged battery.
- Comply with checklist (▣▣▣▶ 64).

Technical data

Troubleshooting chart	122
Screw connections	123
Fuel.....	125
Engine oil	126
Engine	126
Clutch	127
Transmission	127
Final drive.....	128
Frame	128
Chassis	129
Brakes	130
Wheels and tyres	131
Electrical system.....	132
Dimensions	133
Weights.....	134

Performance figures	134
---------------------------	-----

Troubleshooting chart

The engine does not start.





Possible cause	Rectification
Side stand is extended and gear is engaged.	Retract the side stand.
Gear is engaged and clutch is not pressed.	Select neutral or pull the clutch lever.
Fuel tank is empty.	Fuel grade (▣→ 70).
Battery is flat.	Recharging connected battery (▣→ 106).
Starter motor overheating protection has tripped. The starter motor can be operated for a limited time only.	Allow the starter motor to cool down for approximately 1 minute before trying again.

Screw connections

Front wheel	Value	Valid
Brake caliper to telescopic fork		
M10 x 40 x 1.25	38 Nm	
Clamping bolts in axle holder		
M8 x 35	Tightening sequence: Tighten screws six times in alternate sequence	
	19 Nm	
Screw to quick-release axle		
M20 x 1.5	50 Nm	
Wheel-speed sensor to fork leg		
M6 x 20	8 Nm	
Rear wheel	Value	Valid
Rear wheel to wheel carrier		
M10 x 53 x 1.25	Tightening sequence: Tighten in diagonally opposite sequence	
	60 Nm	

Mirror arm	Value	Valid
Mirror (lock nut) to adapter		
M10 x 1.25	Left-hand thread, 22 Nm	
Adapter to clamping block		
M10	25 Nm	

Fuel

Recommended fuel grade	 Super plus, unleaded (max. 5 % ethanol, E5) 98 ROZ/RON  93 AKI
Alternative fuel grade	 Premium unleaded (maximum 15% ethanol, E15)  95 ROZ/RON
Fuel tank capacity	approx. 17.0 l
Fuel reserve	approx. 3.5 l
Fuel consumption	5.3 l/100 km, according to WMTC
CO2 emission	123 g/km, according to WMTC
Exhaust emissions standard	Euro 4

Engine oil

Engine oil, capacity	approx. 3.95 l, with filter change
Specification	SAE 15W-50, API SJ / JASO MA2, Additives (e.g. molybdenum-based) are not permissible because they can attack coated components of the engine, BMW Motorrad recommends BMW Motorrad ADVANTEC Pro oil.
Engine oil, quantity for topping up	max 0.5 l, Difference between MIN and MAX

BMW recommends **ADVANTEC**
ORIGINAL BMW ENGINE OIL

Engine

Engine number location	Crankcase, bottom right, below starter motor
Engine type	12 2E J
Engine design	Air/oil-cooled two-cylinder, four-stroke, opposed-twin engine with two overhead spur gear-driven camshafts and a counterbalance shaft
Displacement	1170 cm ³
Cylinder bore	101 mm
Piston stroke	73 mm
Compression ratio	12.0:1

Nominal capacity	81 kW, at engine speed: 7750 min ⁻¹
Torque	116 Nm, at engine speed: 6000 min ⁻¹
Maximum engine speed	max 8500 min ⁻¹
Idle speed	1150 ^{±50} min ⁻¹ , Engine at regular operating temperature

Clutch

Clutch type	Single-plate dry clutch
-------------	-------------------------

Transmission

Type of transmission	Helically cut 6-speed transmission with integrated torsional vibration damper, claw shift using sliding sleeve
Gearbox transmission ratios	1.737, Primary transmission ratio 2.375 (38:16 teeth), 1st gear 1.696 (39:23 teeth), 2nd gear 1.296 (35:27 teeth), 3rd gear 1.065 (33:31 teeth), 4th gear 0.939 (31:33 teeth), 5th gear 0.848 (28:33 teeth), 6th gear

Final drive

Type of final drive	Shaft drive with bevel gears
Type of rear suspension	Cast aluminium single swinging arm featuring BMW Motorrad Paralever
Gear ratio of final drive	2.910 (32/11 teeth)
Rear axle differential oil	SAE 70W-80 / Hypoid Axle G3

Frame

Frame type	Tubular spaceframe with partially load-bearing drive unit
Type plate location	Frame, front left at steering head
Position of the vehicle identification number	Main frame front right at bottom

Chassis

Front wheel

Type of front suspension	Telescopic forks
Spring travel, front	125 mm, at wheel

Rear wheel

Type of rear suspension	Cast aluminium single swinging arm featuring BMW Motorrad Paralever
Type of rear-wheel suspension	Central spring strut with coil spring, adjustable rebound stage damping and spring preload
Spring travel at rear wheel	120 mm
Recommended suspension setting for one-up riding	18 mm to the beginning of the thread, Spring preload Turn the adjusting screw all the way clockwise, then back it off 1.75 turns, Damping
Recommended suspension setting for riding with load	21 mm to the beginning of the thread, Spring preload Turn the adjusting screw all the way clockwise, then back it off 1.25 turns, Damping
Recommended suspension setting for two-up riding	28 mm to the beginning of the thread, Spring preload Turn the adjusting screw all the way clockwise, then back it off 0.5 turns, Damping

Brakes

Front wheel

Type of front brake	Hydraulically operated twin disc brake with 4-piston fixed calipers and floating brake discs
Brake-pad material, front	Sintered metal
Brake disc thickness, front	min 4 mm, Wear limit

Rear wheel

Type of rear brake	Hydraulically actuated disc brake with 2-piston floating caliper and fixed disc
Brake-pad material, rear	Organic material
Brake disc thickness, rear	min 4.5 mm, Wear limit

Wheels and tyres

Speed category, front/rear tyres	V, required at least: 240 km/h
Front wheel	
Front-wheel type	Spoked wheel
Front-wheel rim size	3.5" x 17"
Tyre designation, front	120/70 ZR 17
Load index, front tyre	min. 58
Permissible front-wheel imbalance	max 5 g
Rear wheel	
Rear-wheel type	Spoked wheel
Rear wheel rim size	5.50" x 17"
Tyre designation, rear	180/55 ZR 17
Load index, rear tyre	min. 73
Permissible rear-wheel imbalance	max 5 g
Tyre pressures	
Tyre pressure, front	2.5 bar, One-up and two-up with luggage, tyre cold
Tyre pressure, rear	2.7 bar, One-up, tyre cold 2.9 bar, Two-up mode with load, with cold tyres

Electrical system

Fuses

Fuse 1	10 A, Instrument cluster, anti-theft alarm system (DWA), ignition switch, OBD diagnostic socket, ignition coil isolating relay
Fuse 2	4 A, ABS control unit, engine control unit, output of isolating relay, speedometer, rev counter, alternator
Electrical rating of on-board socket	5 A

Battery

Battery type	AGM battery (Absorbent Glass Mat)
Battery rated voltage	12 V
Battery rated capacity	12 Ah

Spark plugs

Spark plugs, manufacturer and designation	NGK MAR8B-JDS
---	---------------

Lighting

Bulb for low-beam and high-beam headlight	H4 / 12 V / 60/55 W
Bulb for parking light	W5W / 12 V / 5 W
Bulb for tail light/brake light	LED
Bulbs for flashing turn indicators, front	RY10W / 12 V / 10 W
Bulbs for flashing turn indicators, rear	RY10W / 12 V / 10 W

Dimensions

Length of motorcycle	2105 mm, measured over rear wheel
Height of motorcycle	1240 mm, measured over mirrors, at DIN unladen weight
Width of motorcycle	876 mm, measured over hand levers
Height of rider's seat	805 mm, measured without rider, at DIN unladen weight
Rider's inside-leg arc, heel to heel	1785 mm, measured without rider, at DIN unladen weight

Weights

Vehicle kerb weight	219 kg, DIN unladen weight, ready for road, 90 % load of fuel, without OE
Permissible gross vehicle weight	430 kg
Maximum payload	211 kg

Performance figures

Top speed	>200 km/h
-----------	-----------

Service

BMW Motorrad Service	136
BMW Motorrad Service history	136
BMW Motorrad mobility services	137
Maintenance work	137
Maintenance schedule	141
Maintenance confirmations	142
Service confirmations	156

BMW Motorrad Service

BMW Motorrad has an extensive network of dealerships in place to look after you and your motorcycle in more than 100 countries. Authorised BMW Motorrad dealerships have the technical information and the technical know-how to carry out reliably all maintenance and repair work on your BMW.

You can locate the nearest authorised BMW Motorrad dealership by visiting our website:

bmw-motorrad.com



WARNING

Maintenance and repair work not in compliance with correct procedure

Risk of accident due to consequential damage

- BMW Motorrad recommends having work of this nature carried out on the vehicle by a

specialist workshop, preferably an authorised BMW Motorrad dealer. ◀

In order to help ensure that your BMW is always in optimum condition, BMW Motorrad recommends compliance with the maintenance intervals specified for your motorcycle.

Have all maintenance and repair work carried out confirmed in the "Service" chapter in this manual. Evidence of regular maintenance is essential for generous treatment of claims submitted after the warranty period has expired.

Your authorised BMW Motorrad dealer can provide information on BMW services and the work undertaken as part of each service.

BMW Motorrad Service history

Entries

Maintenance work that has been carried out is entered in the proof of maintenance. The entries are like a Service Booklet and provide proof of regular maintenance.

If an entry is made in the electronic service booklet of the vehicle, service-relevant data is saved in the central IT systems of BMW AG, Munich.

If there is a change in vehicle owner, the data saved in the electronic service booklet can also be viewed by the new vehicle owner. A BMW Motorrad Retailer or a specialist workshop can also view data that is stored in the electronic service booklet.

Objection

The vehicle owner can object to entries being made by the BMW Motorrad Retailer or a specialist workshop in the electronic service booklet along with the corresponding storage of data in the vehicle and transfer of data to the vehicle manufacturer for the period of time that they are the vehicle owner. In this instance, no entry is made in the electronic service booklet of the vehicle.

BMW Motorrad mobility services

As the owner of a new BMW motorcycle, in the event of a breakdown you can benefit from the protection afforded by the various BMW Motorrad mobility services (e.g. BMW Mobile Service, breakdown service, vehicle recovery service).

Your authorised BMW Motorrad dealer will be happy provide information about the mobility services available to you.

Maintenance work

BMW pre-delivery check

Your authorised BMW Motorrad dealer conducts the BMW pre-delivery check before handing over the vehicle to you.

BMW Running-in check

The BMW running-in check has to be performed when the vehicle has covered between 500 km and 1200 km.

BMW Service

The BMW Service is carried out once a year; the extent of servicing can vary, depending on the age of the vehicle and the distance it has covered. Your authorised BMW Motorrad dealer confirms that the service work

has been carried out and enters the date when the next service will be due.

Riders who cover long distances in a year might have to bring in their vehicles for service before the next scheduled date. It is to allow for these cases that a maximum odometer reading is entered as well in the confirmation of service. Servicing has to be brought forward if this odometer reading is reached before the next scheduled date for the service.

The service display in the multifunction display reminds you about one month or 1000 km in advance when the time for a service is approaching, on the basis of the programmed values.

To find out more about service go to:

bmw-motorrad.com/service

The maintenance tasks necessary for your vehicle are set out in the maintenance schedule below.

Maintenance schedule

- 1** BMW running-in check (including oil change)
- 2** BMW Service, standard scope
- 3** Engine-oil change, with filter
- 4** Oil change in bevel gears rear
- 5** Check valve clearances
- 6** Change transmission oil
- 7** Replace all spark plugs
- 8** Replace air filter insert
- 9** Replace belt for alternator
- 10** Adjust engine synchronisation
- 11** Change brake fluid, entire system
 - a annually or every 10.000 km (whichever comes first)
 - b every 2 years or every 20.000 km (whichever comes first)
 - c for the first time after one year, then every two years or 40.000 km (whichever comes first)
 - d every six years or every 40.000 km (whichever comes first)
 - e for the first time after one year, then every two years

Maintenance confirmations

BMW Service standard scope

The repair tasks in the BMW Service standard scope are listed below. The actual scope of maintenance work applicable for your vehicle may vary.

- Performing vehicle test with BMW Motorrad diagnostic system
- Visual inspection of clutch system
- Checking steering-head bearing
- Visual inspection of the brake lines, brake hoses and connections
- Checking front brake pads and brake discs for wear
- Checking brake-fluid level, front wheel brake
- Checking rear brake pads and brake disc for wear
- Checking brake-fluid level, rear wheel brake
- Checking ease of movement of Bowden cables, checking for chafing and kinks and checking play
- Check tyre pressure and tread depth
- Check the side stand's ease of movement
- Checking spoke tension, adjusting if necessary
- Check lighting and signalling system
- Function test, engine start suppression
- Final inspection and check for road safety
- Set service date and remaining distance with BMW Motorrad diagnosis system
- Checking battery state of charge
- Confirming BMW service in on-board literature

BMW pre-delivery check

carried out

at _____

Stamp, signature

BMW Running-in Check

carried out

at _____

at km _____

Next service

at the latest

at _____

or, when reached earlier

at km _____

Stamp, signature

BMW Service

carried out

at _____

at km _____

Next service

at the latest

at _____

or, when reached earlier

at km _____

Stamp, signature

Work performed

BMW Service

Oil change, engine, with filter

Oil change in rear bevel gears

Checking valve clearance

Change gearbox oil

Renewing all spark plugs

Renewing air cleaner insert

Replacing belt for generator

Adjust engine synchronisation

Changing brake fluid, front brakes

Changing brake fluid, rear brakes

Yes

No

Notes

BMW Service

carried out

at _____

at km _____

Next service

at the latest

at _____

or, when reached earlier

at km _____

Stamp, signature

Work performed

BMW Service

Oil change, engine, with filter

Oil change in rear bevel gears

Checking valve clearance

Change gearbox oil

Renewing all spark plugs

Renewing air cleaner insert

Replacing belt for generator

Adjust engine synchronisation

Changing brake fluid, front brakes

Changing brake fluid, rear brakes

Yes

No

Notes

BMW Service

carried out

at _____

at km _____

Next service

at the latest

at _____

or, when reached earlier

at km _____

Stamp, signature

Work performed

BMW Service

Oil change, engine, with filter

Oil change in rear bevel gears

Checking valve clearance

Change gearbox oil

Renewing all spark plugs

Renewing air cleaner insert

Replacing belt for generator

Adjust engine synchronisation

Changing brake fluid, front brakes

Changing brake fluid, rear brakes

Notes

Yes No

BMW Service

carried out

at _____

at km _____

Next service

at the latest

at _____

or, when reached earlier

at km _____

Stamp, signature

Work performed

BMW Service

Oil change, engine, with filter

Oil change in rear bevel gears

Checking valve clearance

Change gearbox oil

Renewing all spark plugs

Renewing air cleaner insert

Replacing belt for generator

Adjust engine synchronisation

Changing brake fluid, front brakes

Changing brake fluid, rear brakes

Yes

No

Notes

BMW Service

carried out

at _____

at km _____

Next service

at the latest

at _____

or, when reached earlier

at km _____

Stamp, signature

Work performed

BMW Service

Oil change, engine, with filter

Oil change in rear bevel gears

Checking valve clearance

Change gearbox oil

Renewing all spark plugs

Renewing air cleaner insert

Replacing belt for generator

Adjust engine synchronisation

Changing brake fluid, front brakes

Changing brake fluid, rear brakes

Yes

No

Notes

BMW Service

carried out

at _____

at km _____

Next service

at the latest

at _____

or, when reached earlier

at km _____

Stamp, signature

Work performed

BMW Service

Oil change, engine, with filter

Oil change in rear bevel gears

Checking valve clearance

Change gearbox oil

Renewing all spark plugs

Renewing air cleaner insert

Replacing belt for generator

Adjust engine synchronisation

Changing brake fluid, front brakes

Changing brake fluid, rear brakes

Notes

Yes

No

BMW Service

carried out

at _____

at km _____

Next service

at the latest

at _____

or, when reached earlier

at km _____

Stamp, signature

Work performed

BMW Service

Oil change, engine, with filter

Oil change in rear bevel gears

Checking valve clearance

Change gearbox oil

Renewing all spark plugs

Renewing air cleaner insert

Replacing belt for generator

Adjust engine synchronisation

Changing brake fluid, front brakes

Changing brake fluid, rear brakes

Yes

No

Notes

BMW Service

carried out

at _____

at km _____

Next service

at the latest

at _____

or, when reached earlier

at km _____

Stamp, signature

Work performed

BMW Service

Oil change, engine, with filter

Oil change in rear bevel gears

Checking valve clearance

Change gearbox oil

Renewing all spark plugs

Renewing air cleaner insert

Replacing belt for generator

Adjust engine synchronisation

Changing brake fluid, front brakes

Changing brake fluid, rear brakes

Notes

Yes

No

BMW Service

carried out

at _____

at km _____

Next service

at the latest

at _____

or, when reached earlier

at km _____

Stamp, signature

Work performed

BMW Service

Oil change, engine, with filter

Oil change in rear bevel gears

Checking valve clearance

Change gearbox oil

Renewing all spark plugs

Renewing air cleaner insert

Replacing belt for generator

Adjust engine synchronisation

Changing brake fluid, front brakes

Changing brake fluid, rear brakes

Yes

No

Notes

BMW Service

carried out

at _____

at km _____

Next service

at the latest

at _____

or, when reached earlier

at km _____

Work performed

BMW Service

Yes

No

Oil change, engine, with filter

Oil change in rear bevel gears

Checking valve clearance

Change gearbox oil

Renewing all spark plugs

Renewing air cleaner insert

Replacing belt for generator

Adjust engine synchronisation

Changing brake fluid, front brakes

Changing brake fluid, rear brakes

Notes

Stamp, signature

Appendix

Declaration of conformity for electronic immobiliser	160
Certificate for electronic immobiliser	166
Certificate for anti-theft alarm	168

Declaration of Conformity

Radio equipment electronic immobiliser (EWS)

Simplified EU Declaration of Conformity acc. Radio Equipment Directive 2014/53/EU after 12.06.2016 and during transition period



Technical information

Frequency Band: 134 kHz
(Transponder: TMS37145 / TypeDST80,
TMS3705 Transponder Base Station IC)
Output Power : 50 dBµV/m

Manufacturer and Address

Manufacturer: BECOM Electronics GmbH
Adress: Technikerstraße 1, A-7442 Hochstraß

Austria

Hiermit erklärt BECOM Electronics GmbH, dass der Funkanlagentyp EWS4 der Richtlinie 2014/53/EU entspricht.
Der vollständige Text der EU-Konformitätserklärung ist unter der folgenden Internetadresse verfügbar:
<http://www.becom.at/de/download/>

Belgium

Le soussigné, BECOM Electronics GmbH, déclare que l'équipement radioélectrique du type EWS4 est conforme à la directive 2014/53/UE.
Le texte complet de la déclaration UE de conformité est disponible à l'adresse internet suivante:
<http://www.becom.at/de/download/>

Bulgaria

С настоящото BECOM Electronics GmbH декларира, че този тип радиосъоръжение EWS4 е в съответствие с Директива 2014/53/ЕС.
Цялостният текст на ЕС декларацията за съответствие може да се намери на следния интернет адрес:
<http://www.becom.at/de/download/>

Cyprus

Με την παρούσα ο/η BECOM Electronics GmbH, δηλώνει ότι ο ραδιοεξοπλισμός EWS4 πληροί την οδηγία 2014/53/EE.

Το πλήρες κείμενο της δήλωσης συμμόρφωσης EE διατίθεται στην ακόλουθη ιστοσελίδα στο διαδίκτυο: <http://www.becom.at/de/download/>

Czech Republic

Tímto BECOM Electronics GmbH prohlašuje, že typ rádiového zařízení EWS4 je v souladu se směrnicí 2014/53/EU.

Úplné znění EU prohlášení o shodě je k dispozici na této internetové adrese:

<http://www.becom.at/de/download/>

Germany

Hiermit erklärt BECOM Electronics GmbH, dass der Funkanlagentyp EWS4 der Richtlinie 2014/53/EU entspricht.

Der vollständige Text der EU-Konformitätserklärung ist unter der folgenden Internetadresse verfügbar:

<http://www.becom.at/de/download/>

Denmark

Hermed erklærer BECOM Electronics GmbH, at radioudstyrstypen EWS4 er i overensstemmelse med direktiv 2014/53/EU.

EU-overensstemmelseserklæringens fulde tekst kan findes på følgende internetadresse:

<http://www.becom.at/de/download/>

Estonia

Käesolevaga deklareerib BECOM Electronics GmbH, et käesolev raadioseadme tüüp EWS4 vastab direktiivi 2014/53/EL nõuetele.

ELi vastavusdeklaratsiooni täielik tekst on kättesaadav järgmisel internetiaadressil:

<http://www.becom.at/de/download/>

Spain

Por la presente, BECOM Electronics GmbH declara que el tipo de equipo radioeléctrico EWS4 es conforme con la Directiva 2014/53/UE.

El texto completo de la declaración UE de conformidad está disponible en la dirección Internet siguiente:

<http://www.becom.at/de/download/>

Finland

BECOM Electronics GmbH vakuuttaa, että radiolaitetyyppi EWS4 on direktiivin 2014/53/EU mukainen.

EU-vaatimustenmukaisuusvakuutuksen täysimittainen teksti on saatavilla seuraavassa internetosoitteessa:
<http://www.becom.at/de/download/>

France

Le soussigné, BECOM Electronics GmbH, déclare que l'équipement radioélectrique du type EWS4 est conforme à la directive 2014/53/UE. Le texte complet de la déclaration UE de conformité est disponible à l'adresse internet suivante: <http://www.becom.at/de/download/>

United Kingdom

Hereby, BECOM Electronics GmbH declares that the radio equipment type EWS4 is in compliance with Directive 2014/53/EU. The full text of the EU declaration of conformity is available at the following internet address:
<http://www.becom.at/de/download/>

Greece

Με την παρούσα ο/η BECOM Electronics GmbH, δηλώνει ότι ο ραδιοεξοπλισμός EWS4 πληροί την οδηγία 2014/53/ΕΕ. Το πλήρες κείμενο της δήλωσης συμμόρφωσης ΕΕ διατίθεται στην ακόλουθη ιστοσελίδα στο διαδίκτυο: <http://www.becom.at/de/download/>

Croatia

BECOM Electronics GmbH ovime izjavljuje da je radijska oprema tipa EWS4 u skladu s Direktivom 2014/53/EU. Cjeloviti tekst EU izjave o sukladnosti dostupan je na sljedećoj internetskoj adresi:
<http://www.becom.at/de/download/>

Hungary

BECOM Electronics GmbH igazolja, hogy a EWS4 típusú rádióberendezés megfelel a 2014/53/EU irányelvnek. Az EU-megfelelőségi nyilatkozat teljes szövege elérhető a következő internetes címen:
<http://www.becom.at/de/download/>

Ireland

Hereby, BECOM Electronics GmbH declares that the radio equipment type EWS4 is in compliance with Directive 2014/53/EU.

The full text of the EU declaration of conformity is available at the following internet address:

<http://www.becom.at/de/download/>

Italy

Il fabbricante, BECOM Electronics GmbH, dichiara che il tipo di apparecchiatura radio EWS4 è conforme alla direttiva 2014/53/UE.

Il testo completo della dichiarazione di conformità UE è disponibile al seguente indirizzo Internet:

<http://www.becom.at/de/download/>

Lithuania

Aš, BECOM Electronics GmbH, patvirtinu, kad radijo įrenginių tipas EWS4 atitinka Direktyvą 2014/53/ES.

Visas ES atitikties deklaracijos teksto prieinamas šiuo interneto adresu:

<http://www.becom.at/de/download/>

Luxembourg

Le soussigné, BECOM Electronics GmbH, déclare que l'équipement radioélectrique du type EWS4 est conforme à la directive 2014/53/UE.

Le texte complet de la déclaration UE de conformité est disponible à l'adresse internet suivante:

<http://www.becom.at/de/download/>

Latvia

Ar šo BECOM Electronics GmbH deklarē, ka radioiekārta EWS4 atbilst Direktīvai 2014/53/ES. Pilns ES atbilstības deklarācijas teksts ir pieejams šādā interneta vietnē:

<http://www.becom.at/de/download/>

Malta

B'dan, BECOM Electronics GmbH, niddikjara li dan it-tip ta' tagħmir tar-radju EWS4 huwa konformi mad-Direttiva 2014/53/UE.

It-test kollu tad-dikjarazzjoni ta' konformità tal-UE huwa disponibbli f'dan l-indirizz tal-Internet li ġej:

<http://www.becom.at/de/download/>

Netherlands

Hierbij verklaar ik, BECOM Electronics GmbH, dat het type radioapparatuur EWS4 conform is met Richtlijn 2014/53/EU.

De volledige tekst van de EU-conformiteitsverklaring kan worden geraadpleegd op het volgende internetadres:
<http://www.becom.at/de/download/>

Poland

BECOM Electronics GmbH niniejszym oświadcza, że typ urządzenia radiowego EWS4 jest zgodny z dyrektywą 2014/53/EU.

Pełny tekst deklaracji zgodności UE jest dostępny pod następującym adresem internetowym:
<http://www.becom.at/de/download/>

Portugal

O(a) abaixo assinado(a) BECOM Electronics GmbH declara que o presente tipo de equipamento de rádio EWS4 está em conformidade com a Diretiva 2014/53/EU.

O texto integral da declaração de conformidade está disponível no seguinte endereço de Internet:
<http://www.becom.at/de/download/>

Romania

Prin prezenta, BECOM Electronics GmbH declară că tipul de echipamente radio EWS4 este în conformitate cu Directiva 2014/53/UE.

Textul integral al declarației UE de conformitate este disponibil la următoarea adresă internet:
<http://www.becom.at/de/download/>

Sweden

Härmed försäkras BECOM Electronics GmbH att denna typ av radioutrustning EWS4 överensstämmer med direktiv 2014/53/EU. Den fullständiga texten till EU-försäkran om överensstämmelse finns på följande webbadress:
<http://www.becom.at/de/download/>

Slovenia

BECOM Electronics GmbH potrjuje, da je tip radijske opreme EWS4 skladen z Direktivo 2014/53/EU.

Celotno besedilo izjave EU o skladnosti je na voljo na naslednjem spletnem naslovu:
<http://www.becom.at/de/download/>

Slovakia

BECOM Electronics GmbH týmto vyhlasuje, že rádiové zariadenie typu EWS4 je v súlade so smernicou 2014/53/EÚ.

Úplné EÚ vyhlásenie o zhode je k dispozícii na tejto internetovej adrese:

<http://www.becom.at/de/download/>

FCC Approval

Ring aerial in the ignition switch



To verify the authorization of the ignition key, the electronic immobilizer exchanges information with the ignition key via the ring aerial.

This device complies with Part 15 of the FCC rules. Operation is subject to the following two conditions:

- (1) This device may not cause harmful interference, and
- (2) this device must accept any interference received, including interference that may cause undesired operation.



Any changes or modifications not expressly approved by the party responsible for compliance could void the user's authority to operate the equipment. ◀

Approbation de la FCC

Antenne annulaire présente dans le commutateur d'allumage



Pour vérifier l'autorisation de la clé de contact, le système d'immobilisation électronique échange des

informations avec la clé de contact via l'antenne annulaire.

Le présent dispositif est conforme à la partie 15 des règles de la FCC. Son utilisation est soumise aux deux conditions suivantes :

- (1) Le dispositif ne doit pas produire d'interférences nuisibles, et
- (2) le dispositif doit pouvoir accepter toutes les interférences extérieures, y compris celles qui pourraient provoquer une activation inopportune.



Toute modification qui n'aurait pas été approuvée expressément par l'organisme responsable de l'homologation peut annuler l'autorisation accordée à l'utilisateur pour utiliser le dispositif. ◀

Declaration of Conformity

Radio equipment anti-theft alarm (DWA)

Simplified EU Declaration of Conformity acc.
Radio Equipment Directive 2014/53/EU after
12.06.2016 and during transition period



Technical information

Frequency Band: 433.05-434.79 MHz
Output Power : 10 mW e.r.p.

Manufacturer and Address

Manufacturer: Meta System S.p.A.
Adress: Via Galimberti 5
42124 Reggio Emilia - Italy –

Austria

Hiermit erklärt Meta System S.p.A., dass der
Funkanlagentyp TXBMWMMR der Richtlinie
2014/53/EU entspricht.
Der vollständige Text der EU-
Konformitätserklärung ist unter der folgenden
Internetadresse verfügbar:
<https://docs.metasystem.it/>

Belgium

Le soussigné, Meta System S.p.A., déclare que
l'équipement radioélectrique du type TXBMWMMR
est conforme à la directive 2014/53/UE.
Le texte complet de la déclaration UE de
conformité est disponible à l'adresse internet
suivante:<https://docs.metasystem.it/>

Bulgaria

С настоящото Meta System S.p.A. декларира, че
този тип радиосъоръжение TXBMWMMR е в
съответствие с Директива 2014/53/ЕС.
Цялостният текст на ЕС декларацията за
съответствие може да се намери на следния
интернет адрес: <https://docs.metasystem.it/>

Cyprus

Με την παρούσα ο/η Meta System S.p.A., δηλώνει ότι ο ραδιοεξοπλισμός TXBMWWR πληροί την οδηγία 2014/53/EE.

Το πλήρες κείμενο της δήλωσης συμμόρφωσης EE διατίθεται στην ακόλουθη ιστοσελίδα στο διαδίκτυο: <https://docs.metasystem.it/>

Czech Republic

Tímto Meta System S.p.A. prohlašuje, že typ rádiového zařízení TXBMWWR je v souladu se směrnici 2014/53/EU.

Úplné znění EU prohlášení o shodě je k dispozici na této internetové adrese: <https://docs.metasystem.it/>

Germany

Hiermit erklärt Meta System S.p.A., dass der Funkanlagentyp TXBMWWR der Richtlinie 2014/53/EU entspricht.

Der vollständige Text der EU-Konformitätserklärung ist unter der folgenden Internetadresse verfügbar: <https://docs.metasystem.it/>

Denmark

Hermed erklærer Meta System S.p.A., at radioudstyrstypen TXBMWWR er i overensstemmelse med direktiv 2014/53/EU. EU-overensstemmelseserklæringens fulde tekst kan findes på følgende internetadresse: <https://docs.metasystem.it/>

Estonia

Käesolevaga deklareerib Meta System S.p.A., et käesolev raadioseadme tüüp TXBMWWR vastab direktiivi 2014/53/EL nõuetele.

ELi vastavusdeklaratsiooni täielik tekst on kättesaadav järgmisel internetiaadressil: <https://docs.metasystem.it/>

Spain

Por la presente, Meta System S.p.A. declara que el tipo de equipo radioeléctrico TXBMWWR es conforme con la Directiva 2014/53/UE.

El texto completo de la declaración UE de conformidad está disponible en la dirección Internet siguiente: <https://docs.metasystem.it/>

Finland

Meta System S.p.A. vakuuttaa, että radiolaitetyyppi TXBMWMMR on direktiivin 2014/53/EU mukainen.

EU-vaatimustenmukaisuusvakuutuksen täysimittainen teksti on saatavilla seuraavassa internetosoitteessa: <https://docs.metasystem.it/>

France

Le soussigné, Meta System S.p.A., déclare que l'équipement radioélectrique du type TXBMWMMR est conforme à la directive 2014/53/UE.

Le texte complet de la déclaration UE de conformité est disponible à l'adresse internet suivante: <https://docs.metasystem.it/>

United Kingdom

Hereby, Meta System S.p.A. declares that the radio equipment type TXBMWMMR is in compliance with Directive 2014/53/EU.

The full text of the EU declaration of conformity is available at the following internet address: <https://docs.metasystem.it/>

Greece

Με την παρούσα ο/η Meta System S.p.A., δηλώνει ότι ο ραδιοεξοπλισμός TXBMWMMR πληροί την οδηγία 2014/53/ΕΕ.

Το πλήρες κείμενο της δήλωσης συμμόρφωσης ΕΕ διατίθεται στην ακόλουθη ιστοσελίδα στο διαδίκτυο: <https://docs.metasystem.it/>

Croatia

Meta System S.p.A. ovime izjavljuje da je radijska oprema tipa TXBMWMMR u skladu s Direktivom 2014/53/EU.

Cjeloviti tekst EU izjave o sukladnosti dostupan je na sljedećoj internetskoj adresi: <https://docs.metasystem.it/>

Hungary

Meta System S.p.A. igazolja, hogy a TXBMWMMR típusú rádióberendezés megfelel a 2014/53/EU irányelvnek.

Az EU-megfeleléségi nyilatkozat teljes szövege elérhető a következő internetes címen: <https://docs.metasystem.it/>

Ireland

Hereby, Meta System S.p.A. declares that the radio equipment type TXBMWMR is in compliance with Directive 2014/53/EU. The full text of the EU declaration of conformity is available at the following internet address: <https://docs.metasystem.it/>

Italy

Il fabbricante, Meta System S.p.A., dichiara che il tipo di apparecchiatura radio TXBMWMR è conforme alla direttiva 2014/53/UE. Il testo completo della dichiarazione di conformità UE è disponibile al seguente indirizzo Internet: <https://docs.metasystem.it/>

Lithuania

Aš, Meta System S.p.A., patvirtinu, kad radijo įrenginių tipas TXBMWMR atitinka Direktyvą 2014/53/ES. Visas ES atitikties deklaracijos teksto prieinamas šiuo interneto adresu: <https://docs.metasystem.it/>

Luxembourg

Le soussigné, Meta System S.p.A., déclare que l'équipement radioélectrique du type TXBMWMR est conforme à la directive 2014/53/UE. Le texte complet de la déclaration UE de conformité est disponible à l'adresse internet suivante: <https://docs.metasystem.it/>

Latvia

Ar šo Meta System S.p.A. deklarē, ka radioiekārta TXBMWMR atbilst Direktīvai 2014/53/ES. Pilns ES atbilstības deklarācijas teksts ir pieejams šādā interneta vietnē: <https://docs.metasystem.it/>

Malta

B'dan, Meta System S.p.A., niddikjara li dan it-tip ta' tagħmir tar-radju TXBMWMR huwa konformi mad-Direttiva 2014/53/UE. It-test kollu tad-dikjarazzjoni ta' konformità tal-UE huwa disponibbli f'dan l-indirizz tal-Internet li ġej: <https://docs.metasystem.it/>

Netherlands

Hierbij verklaar ik, Meta System S.p.A., dat het type radioapparatuur TXBMWMR conform is met Richtlijn 2014/53/EU.

De volledige tekst van de EU-conformiteitsverklaring kan worden geraadpleegd op het volgende internetadres:
<https://docs.metasystem.it/>

Poland

Meta System S.p.A. niniejszym oświadcza, że typ urządzenia radiowego TXBMWMR jest zgodny z dyrektywą 2014/53/EU.

Pełny tekst deklaracji zgodności UE jest dostępny pod następującym adresem internetowym:
<https://docs.metasystem.it/>

Portugal

O(a) abaixo assinado(a) Meta System S.p.A. declara que o presente tipo de equipamento de rádio TXBMWMR está em conformidade com a Diretiva 2014/53/EU.

O texto integral da declaração de conformidade está disponível no seguinte endereço de Internet:
<https://docs.metasystem.it/>

Romania

Prin prezenta, Meta System S.p.A. declară că tipul de echipamente radio TXBMWMR este în conformitate cu Directiva 2014/53/UE.

Textul integral al declarației UE de conformitate este disponibil la următoarea adresă internet:
<https://docs.metasystem.it/>

Sweden

Härmed försäkras Meta System S.p.A. att denna typ av radioutrustning TXBMWMR överensstämmer med direktiv 2014/53/EU. Den fullständiga texten till EU-försäkran om överensstämmelse finns på följande webbadress:
<https://docs.metasystem.it/>

Slovenia

Meta System S.p.A. potrjuje, da je tip radijske opreme TXBMWMR skladen z Direktivo 2014/53/EU.

Celotno besedilo izjave EU o skladnosti je na voljo na naslednjem spletnem naslovu:
<https://docs.metasystem.it/>

Slovakia

Meta System S.p.A. týmto vyhlasuje, že rádiové zariadenie typu TXBMWMR je v súlade so smernicou 2014/53/EÚ.

Úplné EÚ vyhlásenie o zhode je k dispozícii na tejto internetovej adrese:

<https://docs.metasystem.it/>

A

- Abbreviations and symbols, 6
- ABS
 - Engineering details, 76
 - Indicator and warning light, 32
 - operating, 51
 - Self-diagnosis, 65
- Accessories
 - General instructions, 112
- Anti-theft alarm
 - activating, 47
 - adjusting, 48
 - deactivating, 48
 - Indicator light, 21
 - operating, 47
 - Warning, 34
- ASC
 - Engineering details, 78
 - Indicator and warning light, 33
 - operating, 52
 - Self-diagnosis, 66
 - switching off, 52
 - switching on, 52
- Automatic Stability Control
 - ASC, 78

B

- Battery
 - Maintenance instructions, 105
 - Position on the vehicle, 18
 - recharging connected battery, 106
 - recharging disconnected battery, 107
 - Replacing battery, 107
 - Technical data, 132
 - Voltage of the vehicle electrical system too low, 31
- Brake fluid
 - Checking fluid level, front, 89
 - Checking fluid level, rear, 90
 - Reservoir, front, 17
 - Reservoir, rear, 17
- Brake pads
 - checking front, 87
 - checking rear, 88
 - Running in, 67

Brakes

- Adjusting handlebar levers, 57
- Checking function, 87
- Safety instructions, 68
- Technical data, 130
- Wear indicator, 89

C

- Care
 - Chrome, 117
 - Paintwork preservation, 118
- Chassis
 - Technical data, 129
- Checklist, 64
- Clock
 - adjusting, 48
 - Display: CLOCK, 44
- Clutch
 - Adjusting handlebar levers, 57
 - Checking function, 91
 - Fluid reservoir, 15
 - Technical data, 127
- Coolant
 - Warning light for overheating, 30

Coolant temperature
 Display: ENGTMP, 44
 too high, 30
Currency, 7

D

Damping
 adjusting, 59
Date
 adjusting, 49
Diagnostic connector
 disengaging, 109
 securing, 109
Dimensions
 Technical data, 133
Display
 Adjusting brightness, 50
Distance recorders
 Control, 21
 reset, 46

E

Electrical system
 Technical data, 132

Emergency off switch (kill
 switch), 20
 operating, 40
Engine
 Engine electronics indicator
 light, 30
 Malfunction indicator lamp, 31
 severe fault, 31
 starting, 64
 Technical data, 126

Engine oil
 Checking fill level, 85
 Filler neck, 17
 Fill-level indicator, 15
 Technical data, 126
 top up, 86
Equipment, 7

F

Final drive
 Technical data, 128
Frame
 Technical data, 128
Front-wheel stand
 installing, 83

Fuel
 Filler neck, 15
 Fuel reserve, 34
 Refuelling, 70
 Technical data, 125
Fuel reserve
 Display distance covered:
 TRIP R, 44
 Indicator light, 34
Fuses
 Fuse assignment, 108
 replacing, 107
 Technical data, 132

G

General views
 Indicator and warning lights, 24
 Instrument cluster, 21
 Left multifunction switch, 19
 Left side of vehicle, 15
 Multifunction display, 25
 Right handlebar fitting, 20
 right side of vehicle, 17
 Underneath the seat, 18

H

Hazard warning flashers

Control, 19

operating, 42

Headlight

Adjustment for right-hand/left-hand traffic, 56

Headlight beam throw, 56

Removing and installing, 99

Headlight courtesy delay

feature, 41

Heated handlebar grips

operating, 53

Horn, 19

I

Ignition

switching off, 39

switching on, 38

Immobiliser

Spare key, 39

Warning, 30

Indicator lights, 21

Overview, 24

Instrument cluster

Ambient-light brightness sensor, 21

Overview, 21

J

Jump-starting, 104

K

Keys, 38

L

Lighting

High-beam headlight, 101

Indicator light for faulty bulb, 32

Low-beam headlight, 101

Replacing LED rear light, 104

Side light, 102

Technical data, 133

Turn indicators, 103

Lights

Control, 19

Headlight courtesy delay

feature, 41

Headlight flasher, operating, 41

High-beam headlight,

operating, 41

Low-beam headlight, 40

Parking lights, operating, 41

Side light, 40

Luggage

lashing, 113

M

Maintenance

General instructions, 82

Maintenance schedule, 141

Maintenance confirmations, 142

Maintenance intervals, 137

Malfunction indicator lamp, 31

Mirrors

adjusting, 56

Mobility services, 137

Motorcycle

care, 115

cleaning, 115

lashing, 72

laying up, 118

parking, 69

Preparing for use, 119

Multifunction display, 21
 Overview, 25
 Selecting display, 44

Multifunction switch
 Overview, left side, 19
 Overview, right side, 20

O

Odometer
 Display: ODO, 44

Operating instructions
 Position on the vehicle, 18

P

Parking, 69

Passenger seat
 Lock, 17

Payload table
 Sign, 18

Performance figures
 Technical data, 134

Power socket
 Notes on use, 112
 Position on the vehicle, 15

Pre-Ride-Check, 65

R

Rear-wheel stand
 installing, 84

Refuelling, 70

Rev. counter, 21

Running in, 67

S

Safety instructions
 for brakes, 68
 for riding, 62

Screw connections, 123

Seat, 54
 installing, 54
 Motorcycle seat key, 38
 removing, 54

Service, 136
 Service history, 136

Service-due indicator, 35

Settings
 Display: SETUP ENTER, 44

Spark plugs
 Technical data, 132

Speedometer, 21, 25

Spring preload
 Adjuster, rear, 17
 adjusting, 58

Starting, 64
 Control, 20

Steering lock, 38

T

Technical data
 Battery, 132
 Brakes, 130
 Chassis, 129
 Clutch, 127
 Dimensions, 133
 Electrical system, 132
 Engine, 126
 Engine oil, 126
 Final drive, 128
 Frame, 128
 Fuel, 125
 Fuses, 132
 General instructions, 7
 Lighting, 133
 Performance figures, 134
 Spark plugs, 132

- Standards, 7
- Transmission, 127
- Weights, 134
- Wheels and tyres, 131
- Toolkit
 - Position on the vehicle, 18
- Torques, 123
- Transmission
 - Technical data, 127
- Trip recorder
 - Display: TRIP 1, TRIP 2 or TRIP A, 44
- Troubleshooting chart, 122
- Turn indicators
 - Control, 19
 - operating, 42
- Type plate
 - Position on the vehicle, 15
- Tyre pressures
 - Sign, 18
- Tyres
 - Checking tread depth, 92
 - Checking tyre pressure, 91
 - Pressures, 131
 - Running in, 68
 - Technical data, 131
- V**
 - Vehicle Identification Number
 - Position on the vehicle, 17
- W**
 - Warning indicators
 - ABS, 32
 - Anti-theft alarm, 34
 - ASC, 33
 - Bulb faulty, 32
 - Coolant temperature, 30
 - Electronic immobiliser, 30
 - Engine electronics, 30
 - Engine warning, 31
 - Fuel reserve, 34
 - Malfunction indicator lamp, 31
 - Mode of presentation, 26
 - Overtemperature, 30
 - Overview, 24
 - Voltage of the vehicle electrical system too low, 31
 - Warning lights, 21
 - Warnings, overview, 27
 - Weights
 - Technical data, 134
 - Wheels
 - Change of size, 93
 - Checking rims, 92
 - Checking spokes, 92
 - Installing rear wheel, 99
 - Removing rear wheel, 98
 - Technical data, 131

Details described or illustrated in this booklet may differ from the vehicle's actual specification as purchased, the accessories fitted or the national-market specification. No claims will be entertained as a result of such discrepancies.

Dimensions, weights, fuel consumption and performance data are quoted to the customary tolerances.

The right to modify designs, equipment and accessories is reserved.

Errors and omissions excepted.

© 2019 Bayerische Motoren Werke Aktiengesellschaft
80788 Munich, Germany
Not to be reproduced by any means whatsoever, wholly or in part, without the written permission of BMW Motorrad, After Sales.

Original rider's manual, printed in Germany.

